

DOSIER ILUMINACIÓN RESIDENCIAL



Esanea para ver nuestro Dossier de Iluminación Residencial



Dossier iluminación residencial: La importancia de la luz en el hogar.

La iluminación es el arma secreta para hacer que un espacio pase de ser convencional a extraordinario, fusionando estética y funcionalidad. Este dossier explora planificar y ejecutar un diseño de iluminación residencial que no solo complemente sino que también potencie la decoración y el bienestar en el hogar.

Dossiê Iluminação residencial: A importância da luz no lar.

A iluminação é a arma secreta para transformar um espaço de convencional a extraordinário, fundindo estética e funcionalidade. Este dossiê explora como planejar e executar um design de iluminação residencial que não apenas complemente, mas também potencialize a decoração e o bem-estar no lar.

Residential Lighting Brochure: The importance of light in the home.

Lighting is the secret weapon to transform a space from conventional to extraordinary, blending aesthetics and functionality. This dossier explores how to plan and execute residential lighting design that not only complements but also enhances home decor and well-being.

Dossier Illuminazione residenziale: L'importanza della luce nella casa.

L'illuminazione è l'arma segreta per trasformare uno spazio da convenzionale a straordinario, fondendo estetica e funzionalità. Questo dossier esplora come pianificare ed eseguire un design di illuminazione residenziale che non solo completi, ma esalti anche la decorazione e il benessere della casa.

ILUMINACIÓN DOWNLIGHTS

Downlights | Downlights | Downlight



MODEL	GAMA	W	Lm W											EE LABEL	
NEBOA	LED	6-9 9-12 14-20 24-35 6*	≤110			60°	IP65	CRI80	*D3, D4	220-240V AC	P.F≥0.5		120-130 mm 145-155 mm 195-210 mm 68-76 mm 90-98 mm		PG 74
TROCO LENSE & DIF	LED	10 20 35	126			60°	IP44	CRI80	*D1, D3, D4, D5, D6	220-240V AC	P.F≥0.9		100 mm 150 mm 205 mm		PG 76
PANEL Circular PRO	LED	24 28 32	114			100°	IP54	CRI80	TRIAC *D1, D2, D3, D4, D5, D6	220-240V AC	P.F≥0.9		196 mm 205 mm		PG 78
PANEL Circular IOT	LED	24	100			100°	IP44	CRI80	IOT	220-240V AC	P.F≥0.9		205 mm		PG 80
PANEL IP65	LED	12 18	89			120°	IP65	CRI80	-	220-240V AC	P.F0.7		120 mm 140 mm		PG 82
VERSA	LED	15w/22w/28w 20	90			110°	IP20	CRI	-	220-240V AC	P.F0.9		65-205 mm 65-310 mm		PG 84
Frameless Panel	LED	18 36*	103			120°	IP20	CRI80	*D1, D2, D3, D4, D5, D6	100-240V AC	P.F≥0.9		200 mm 95 mm		PG 86
DOWNLIGHT DLR	LED	35*	100			90°	IP20	CRI80	*D3, D4, D6	220-240V AC	P.F≥0.9		230x130 mm		PG 87
OLLO	LED	10 20 30 40 60	120			40°	IP20	CRI80	*D1, D3, D5	220-240V AC	P.F≥0.9		100x100 mm 100x200 mm 100x300 mm 150x150 mm 150x310 mm 150x460 mm		PG 88
Downlight DWC Round	LED	8,8 10 16 20,8 30 40,8*	131			36° 45° 60°	IP20	CRI82	0-10V *D3, D4, D6	220-240V AC	P.F≥0.9		130 mm 55 mm 65 mm 90 mm		PG 90
ROL	LED	6,5	108			36°	IP20	CRI80	*D1, D3, D5, D6	220-240V AC	P.F≥0.7		87 mm		PG 92
DOWNLIGHT DLC BAS	LED	15 24 40*	100			34° 40°	IP20	CRI80	0-10V *D3, D4, D6	220-240V AC	P.F≥0.9		125-130 mm 170-175 mm 75-80 mm		PG 94
ALL IN PANEL	LED	6 7 14 25	90			40°	IP44	CRI80	TRIAC	220-240V AC	P.F≥0.9		68-73 mm		PG 96
ALL IN O	LED	6,5	92			40°	IP20	CRI80	-	220-240V AC	P.F≥0.5		68-75 mm		PG 98

MODEL	GAMA	W	Lm W												EE LABEL	
PANEL SLIM CIRCULAR 30	LED T	30	93			120°	IP20	CRI80	*D1, D3, D5	100-240V AC	P.F≥0.9		280 mm		PG 99	
PANEL SLIM 18	LED T	18*	94			120°	IP20	CRI80	*D1, D2, D3, D4, D5, D6	175-265V AC	P.F≥0.7		205 mm		PG 100	
PANEL SLIM 12	LED T	12*	81			120°	IP20	CRI80	*D1, D2, D3, D4, D5, D6	175-265V AC	P.F≥0.9		153 mm		PG 102	
PANEL SLIM 6	LED T	6*	80			120°	IP20	CRI80	*D1, D2, D3, D4, D5, D6	100-240V AC	P.F≥0.5		105 mm		PG 104	
PANEL SLIM CIRCULAR 5	LED T	5*	80			120°	IP20	CRI80	*D1, D2, D3, D4, D5, D6	100-240V AC	P.F≥0.5		70 mm 72 mm		PG 106	
PANEL D CIRCULAR	LED T	6 12 18	94			120°	IP20	CRI80	-	100-240V AC	P.F≥0.5		100 mm 153 mm 200 mm		PG 108	
Adjustable Panel	LED T	20*	115			120°	IP20	CRI80	*D1, D2, D3, D4, D5, D6	175-265V AC	P.F≥0.7		50-200 mm		PG 110	
AJ PANEL V2	LED T	15 - 22 - 28 20	90			110°	IP20	CRI82	-	220-240V AC	P.F≥0.9		65-205 mm 65-310 mm		PG 111	
PANEL RR	LED T	18	90			120°	IP20	CRI80	-	220-240V AC	P.F≥0.5		-		PG 112	
MOON	LED T	11 18	81			110°	IP44	CRI80	-	100-277V AC	P.F≥0.9		120 mm 170 mm		PG 114	
Panel Superficie 6	LED T	6*	70			120°	IP20	CRI80	*D1, D2, D3, D4, D5, D6	100-240V AC	P.F≥0.5		-		PG 116	
Panel Superficie Circular 30	LED T	30*	95			120°	IP20	CRI80	*D1, D2, D3, D4, D5, D6	100-240V AC	P.F≥0.9		-		PG 117	
Panel Superficie 12-18	LED T	12 18*	94			120°	IP20	CRI80	*D1, D2, D3, D4, D5, D6	175-265V AC	P.F≥0.7		-		PG 118	



NEBOA



1

2

NEBOA



* Ver | see | vedere pg. 27

REF	W	Lm	Beam	Color	Beam	Beam
2A NEBOA2906BCCT	6	540lm (3000k) - 600lm (4000k) - 570lm (5700k)	3000 / 4000 / 6500	BL	60°	
2B NEBOA2913BCCT	6 9	6W: 600lm (3000k) - 660lm (4000k) - 630lm (5700k) / 9W: 900lm (3000k) - 990lm (4000k) - 945lm (5700k)	3000 / 4000 / 6500	BL	60°	
2C NEBOA2920BCCT	9 12	9W: 945lm (3000k) - 1035lm (4000k) - 990lm (5700k) / 12W: 1260lm (3000k) - 1380lm (4000k) - 1320lm (5700k)	3000 / 4000 / 6500	BL	60°	
1A NEBOA2937BCCT	14 20	14W: 1470lm (3000k) - 1680lm (4000k) - 1540lm (5700k) / 20W: 2100lm (3000k) - 2400lm (4000k) - 2200lm (5700k)	3000 / 4000 / 6500	BL	60°	
1B NEBOA2944BCCT	24 35	24W: 2520lm (3000k) - 2880lm (4000k) - 2640lm (5700k) / 35W: 3675lm (3000k) - 4200lm (4000k) - 3850lm (5700k)	3000 / 4000 / 6500	BL	60°	D3 D4



Dimensiones | Dimensões | Dimensions | Dimensioni

1A	H: 108 mm	Ø: 174 mm	0.4 kg	Ø: 145-155 mm	20
1B	H: 232 mm	Ø: 232 mm	0.625 kg	Ø: 195-210 mm	12
2A	H: 55 mm	Ø: 84 mm	0.142 kg	Ø: 68-76 mm	60
2B	H: 67 mm	Ø: 106 mm	0.225 kg	Ø: 90-98 mm	60
2C	H: 80 mm	Ø: 140 mm	0.375 kg	Ø: 120-130 mm	40

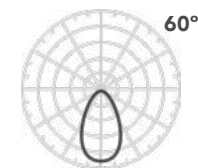

60°

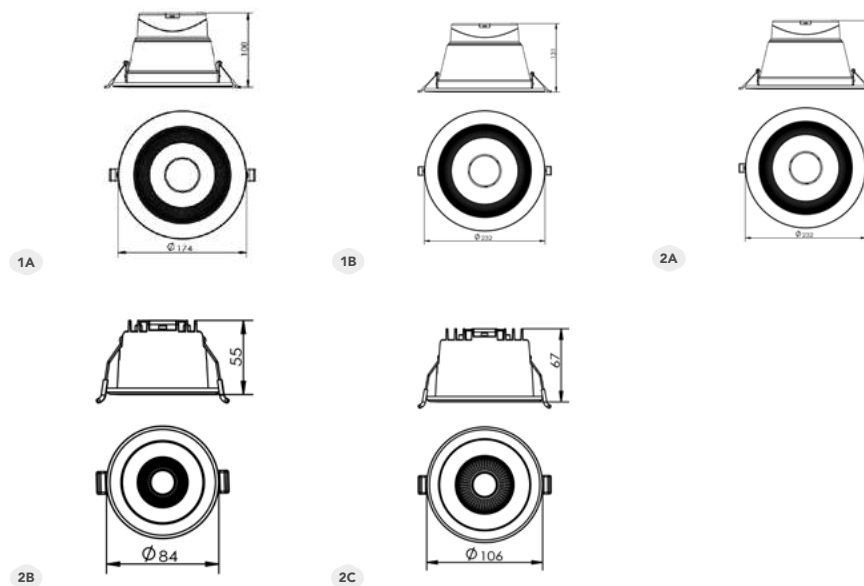

Accesorios | Acessórios | Accessories | Accessori





TROCO



LENSE

DIF

TROCO



* Ver | see | vedere pg. 27

REF	W	Lm	Beam	Color	Beam	Beam	Beam
2 TROCO110TW LENSE	10	943lm(3000K) - 1054lm(4000K) - 994lm(5700K)	3000-4000-5700	BL	60°	D1 D3 D4 D5 D6	E12 E2 E10 E5 E13 E22
3 TROCO115TW LENSE	20	1750lm(3000K) - 1975lm(4000K) - 1918lm(5700K)	3000-4000-5700	BL	60°		E2 E10 E5 E13 E22
1 TROCO120TW LENSE	35	2895lm(3000K) - 3279lm(4000K) - 3179lm(5700K)	3000-4000-5700	BL	60°		
2 TROCO210TW DIF	10	1052lm(3000K) - 1180lm(4000K) - 1123lm(5700K)	3000-4000-5700	BL	80°		
3 TROCO215TW DIF	20	2130lm(3000K) - 2369lm(4000K) - 2278lm(5700K)	3000-4000-5700	BL	80°		
1 TROCO220TW DIF	35	3697lm(3000K) - 4141lm(4000K) - 3952lm(5700K)	3000-4000-5700	BL	80°		

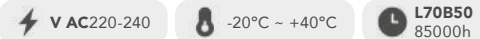

	Dimensiones Dimensões Dimensions Dimensioni	LED
1	H: 110 mm Ø: 232 mm 0.625 kg	∅: 205 mm 12
2	H: 66 mm Ø: 114 mm 0.225 kg	∅: 100 mm 40
3	H: 87 mm Ø: 174 mm 0.4 kg	∅: 150 mm 30

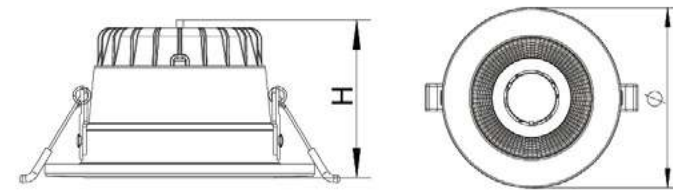
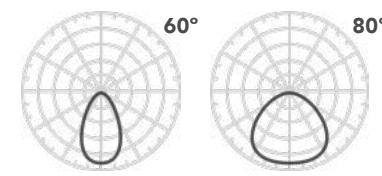

Accesorios | Acessórios | Accessories | Accessori

TROCORD20C TROCO ACCES R pg. 127	TROCORD20N TROCO ACCES R pg. 127	TROCOSQ20B TROCO ACCESS S pg. 126
TROCOSQ20N TROCO ACCESS S pg. 126	TROCORD10C TROCO ACCES R pg. 127	TROCORD10N TROCO ACCES R pg. 127
TROCOSQ10B TROCO ACCESS S pg. 126	TROCOSQ10N TROCO ACCESS S pg. 126	TROCORD15C TROCO ACCES R pg. 127
TROCORD15N TROCO ACCES R pg. 127	TROCOSQ15B TROCO ACCESS S pg. 126	TROCOSQ15N TROCO ACCESS S pg. 126



PANEL CIRCULAR PRO



PANEL Circular PRO



* Ver | see | vedere pg. 27

REF	W	Lm	☼	☒	▲	⌚	⌚	⌚
LEDPANEL24C	24*	2500	3000K	☒ BL	100°	-		
LEDPANEL24F	24*	2600	4000K	☒ BL	100°	-	D1	E2 E10 E5
LEDPANEL24B	24*	2600	6500K	☒ BL	100°	-	D2	E17 E13 E20 E22
LEDPANEL28C	28*	3100	3000K	☒ BL	100°	TRIAC	D4	E13 E10 E5
LEDPANEL28F	28*	3200	4000K	☒ BL	100°	TRIAC	D5	E17 E20 E22
LEDPANEL28B	28*	3200	6500K	☒ BL	100°	TRIAC	D6	

* Más opciones de W disponibles, consultar con un gestor de servicios de ROBLAN | Mais opções W disponíveis, consulte um gerente de serviço ROBLAN.
 * More W options available, consult with a ROBLAN service manager | Altre opzioni W disponibili, consultare un responsabile dell'assistenza ROBLAN.



⊗ Dimensiones | Dimensões | Dimensions | Dimensioni

H: 38 mm Ø: 221 mm 0.58 kg Ⓢ Ø: 196 mm 10

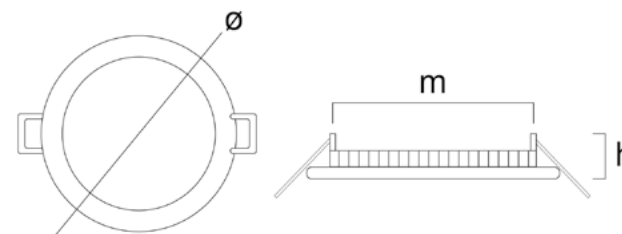
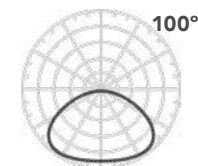

⊕ Accesorios | Acessórios | Accessories | Accessori

TROCOSURF20W | TROCO SURF
pg. 126



PANEL CIRCULAR IOT



PANEL Circular IOT

IP44 CRI80

REF	W	Lm	Beam	BL	Angle	IOT
-----	---	----	------	----	-------	-----

LEDPANEL24IOT	24	2400	2700 / 6500	BL	100°	IOT
---------------	----	------	-------------	----	------	-----

- V AC220-240
- P.F.>0.9
- 20°C ~ +40°C
- 25000

Dimensiones | Dimensões | Dimensions | Dimensioni

H: 69 mm Ø: 220 mm Ø: 205 mm 10

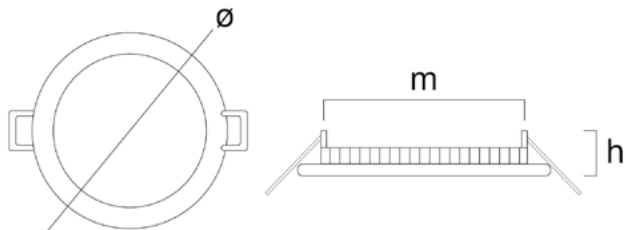
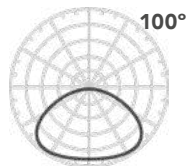

Accesorios | Acessórios | Accessories | Accessori

IOTA60REM | IOT Acces
pg. 51

Control remoto | Remote control | Controllo remoto | Telecomando

CONTROL REMOTO PANEL CIRCULAR

CONTROLO REMOTO
REMOTE CONTROL
TELECOMANDO

- CCT+ / -** **Regulación de tono 8 pasos.**
Regulação de Tom em 8 Passos.
Light temperature regulation 8 steps.
Regolazione del Tono in 8 Passaggi.
- Full Light** **100% Luz | Light | Luce.**
- DIM+ / -** **Regulación intensidad luz 10 pasos.**
Regulação de Intensidade de Luz em 10 Passos.
Light dimming regulation 10 step dim.
Regolazione dell'Intensità della Luce in 10 Passaggi.
- Memoria** **Memorizar el programa deseado.**
Memorizar o Programa Desejado.
Program your desired mode.
Memorizzare il Programma Desiderato.
- Luz Nocturna** **Encendido/Apagado Luz Nocturna**
Luz Noturna Ligada/Desligada
On/Off Night Light
Luce Notturna Accesa/Spenta
- 10-30min** **Apagado automático tras 10 o 30 min**
Desligar Automático após 10 ou 30 minutos
Automatic off timer after 10 to 30min
Spegnimento automatico dopo 10 o 30 minuti
- Timer** **Cancelar Temporizador**
Cancel automatic timer
Annullare il Timer

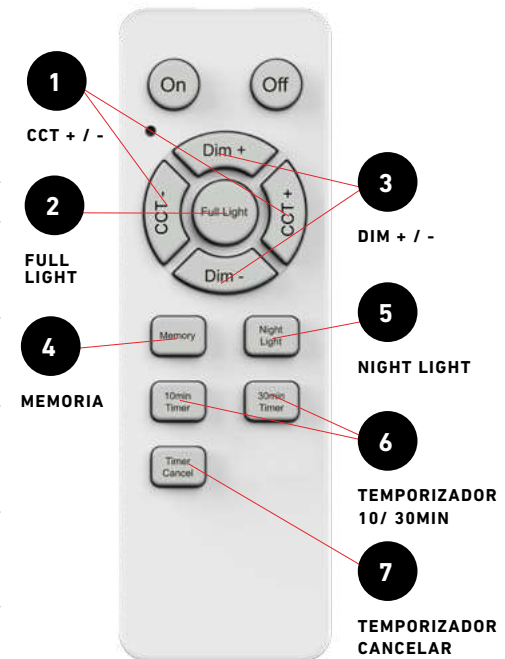







PANEL IP65



1

2

✗ Dimensiones | Dimensões | Dimensions | Dimensioni 

1A	H: 26 mm	Ø: 145 mm	 Ø: 120 mm	60	
1B	H: 26 mm	Ø: 170 mm	 Ø: 140 mm	60	
2A	H: 26 mm	L: 145 mm	W: 145 mm	 120-135 mm	60
2B	H: 26 mm	L: 170 mm	W: 170 mm	 140-160 mm	60

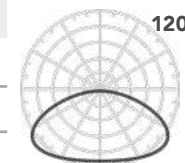

120°

PANEL IP65



REF	W	Lm	Color	Beam	Angle
1A LEDPANELIP6512FB	12	1000	4000K	BL	120°
2A LEDPANELSIP6512FB	12	1000	4000K	BL	120°
1B LEDPANELRIP6518CB	18	1600	3000K	BL	120°
1B LEDPANELRIP6518FB	18	1600	4000K	BL	120°
2B LEDPANELSIP6518FB	18	1600	4000K	BL	120°

 V AC220-240

 P.F.>0.7

 15000

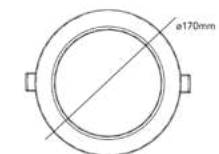
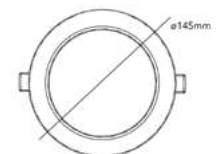
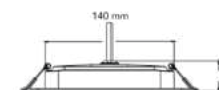
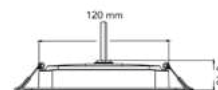

1A

1B

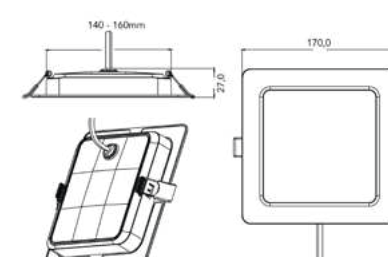
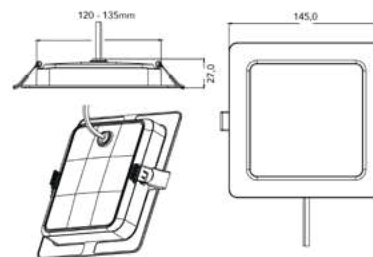

2A

2B



VERSA



VERSA

IP20 IK04 MW + DS

REF	W	Lm	Beam	Color	Angle
1 VERSA4931BCCTS	20	1700lm (3000K) - 1900lm (4000k) - 1800lm (5700k)	3000 / 4000 / 5700	BL	110°

2 VERSA4948BCCTMPS	15w 22w 28w	15W:1200-1400Lm / 22W:1800-2000Lm / 28W:2300-2500Lm	3000 / 4000 / 5700	BL	110°
---------------------------	-----------------	---	--------------------	----	------

V AC220-240 P.F.00.9 -25°C ~ +40°C 15000 L70B50 30000h CCT >W

Watts configurables
Watts configurables / Configurable watts / Watt configurabil

IP20

Modo de sensor de movimiento nocturno
Modo de sensor de movimento noturno / Night motion sensor mode / Modalità sensore di movimento notturno

Ajuste de tiempo 30/180s / Ajuste de tempo 30/180s / Time adjustment 30/180s / Regolazione del tempo 30/180s

Modo de sensor de movimiento / Modo de sensor de movimento / Motion sensor mode / Modalità sensore di movimento

Dimensiones | Dimensões | Dimensions | Dimensioni

1	H: 18 mm	Ø: 220 mm	0.43 kg	Ø: 65-205 mm	20
2	H: 24.7 mm	Ø: 336 mm	0.95 kg	Ø: 65-310 mm	10

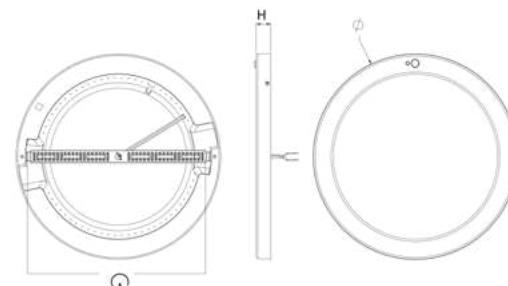
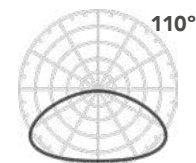

Accesorios | Acessórios | Accessories | Accessori

RING20SENSN ACCESS VERSA pg. 128	RING20SENSS ACCESS VERSA pg. 128	RING30SENSN ACCESS VERSA pg. 128
RING30SENSS ACCESS VERSA pg. 128		

Especificaciones Sensor | Especificações do Sensor | Sensor Specifications | Specifiche del Sensore

Tecnología de Sensor Tecnologia do Sensor Sensor Technology Tecnologia del Sensore	Sensor de Movimiento Microondas + Sensor crepuscular
Altura max Instalación Sensor Altura Máxima de Instalação do Sensor Max Height Installation Sensor Altezza Massima di Installazione del Sensore	4m
Sensibilidad Sensor de Luz Sensibilidade do Sensor de Luz Detection Sensitivity Sensibilità del Sensore di Luce	<13
Ángulo de detección Ângulo de Detecção Detection Angle Angolo di Rilevamento	120
Tiempo de encendido Tempo de Acendimento On/off time length Tempo di Accensione	30/180s

ROBLAN



FRAMELESS ROUND PANEL



Frameless Round Panel



* Ver | see | vedere pg. 27

REF	W	Lm	Color	Beam	Angle	Icon
1 FLPANEL18C	18*	1550	3000K	BL	120°	D1 D2 D3 D4 D5 D6
1 FLPANEL18F	18*	1800	4000K	BL	120°	
1 FLPANEL18B	18*	1850	6500K	BL	120°	
2 FLPANEL36C	36*	3200	3000K	BL	120°	
2 FLPANEL36F	36*	3250	4000K	BL	120°	
2 FLPANEL36B	36*	3300	6500K	BL	120°	

* Más opciones de W disponibles, consultar con un gestor de servicios de ROBLAN | Mais opções W disponíveis, consulte um gerente de serviço ROBLAN.
* More W options available, consult with a ROBLAN service manager | Altre opzioni W disponibili, consultare un responsabile dell'assistenza ROBLAN.



Dimensiones | Dimensões | Dimensions | Dimensioni

1	H: 29 mm	Ø: 118 mm	0.18 kg	Ø: 95 mm	50
2	H: 31 mm	Ø: 220 mm	0.44 kg	Ø: 200 mm	30

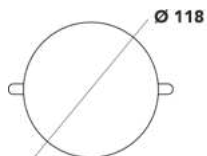
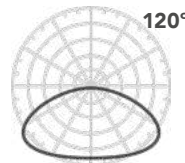

Tamaño de corte / Cut size 95 mm

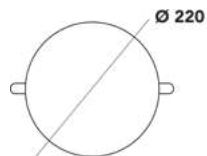

Tamaño de corte / Cut size 200 mm

1

2

ROBLAN



DOWNLIGHT DLR



Downlight DLR



* Ver | see | vedere pg. 27

REF	W	Lm	Color	Beam	Angle	Icon
DLRBAS35BC	35*	3300	3000K	BL	90°	D3 D4 D6
DLRBAS35BF	35*	3500	4100K	BL	90°	
DLRBAS35BB	35*	3500	6500K	BL	90°	

* Más opciones de W disponibles, consultar con un gestor de servicios de ROBLAN | Mais opções W disponíveis, consulte um gerente de serviço ROBLAN.
* More W options available, consult with a ROBLAN service manager | Altre opzioni W disponibili, consultare un responsabile dell'assistenza ROBLAN.



Dimensiones | Dimensões | Dimensions | Dimensioni

H: 88.5 mm L: 241 mm W: 150 mm 2.13 kg 230x130 mm 8

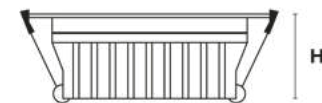
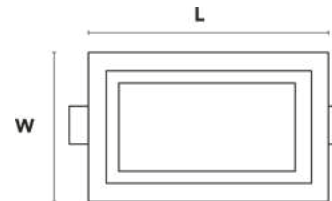
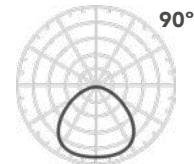



OLLO



1 2 3

OLLO

IP20 IK03 CRI80 DALI

* Ver | see | vedere pg. 27

REF	W	Lm	Color	Beam	Angle	Dimmable	Mount
1A OLLO1010C	10	1100	3000K	BL	40°		E2 E16 E20 E22
1A OLLO1010F	10	1200	4000K	BL	40°		
1A OLLO1010B	10	1200	5700K	BL	40°		
1B OLLO1515C	20	2200	3000K	BL	40°		
1B OLLO1515F	20	2400	4000K	BL	40°		
1B OLLO1515B	20	2400	5700K	BL	40°		
2A OLLO1020C	20	2200	3000K	BL	40°		
2A OLLO1020F	20	2400	4000K	BL	40°		
2A OLLO1020B	20	2400	5700K	BL	40°		
3A OLLO1030C	30	3300	3000K	BL	40°		
3A OLLO1030F	30	3600	4000K	BL	40°		
3A OLLO1030B	30	3600	5700K	BL	40°		
2B OLLO1531C	40	4400	3000K	BL	40°		
2B OLLO1531F	40	4800	4000K	BL	40°		
2B OLLO1531B	40	4800	5700K	BL	40°		
3B OLLO1546C	60	6640	3000K	BL	40°		
3B OLLO1546F	60	7200	4000K	BL	40°		
3B OLLO1546B	60	7200	5700K	BL	40°		

V AC220-240 P.F.>0.9 -20°C ~ +40°C L70B30 85000h

Dimensiones | Dimensões | Dimensions | Dimensioni

Model	H	L	W	Weight	Mounting Hole	Quantity
1A	50.5 mm	120 mm	120 mm	0.3 kg	100x100 mm	30
2A	50.5 mm	120 mm	220 mm	0.5 kg	100x200 mm	20
3A	50.5 mm	120 mm	320 mm	0.7 kg	100x300 mm	20
1B	96 mm	180 mm	180 mm	0.75 kg	150x150 mm	15
2B	96 mm	180 mm	340 mm	1.5 kg	150x310 mm	12
3B	96 mm	180 mm	490 mm	2.167 kg	150x460 mm	6

Poliamida (Nylon) PS

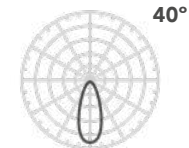
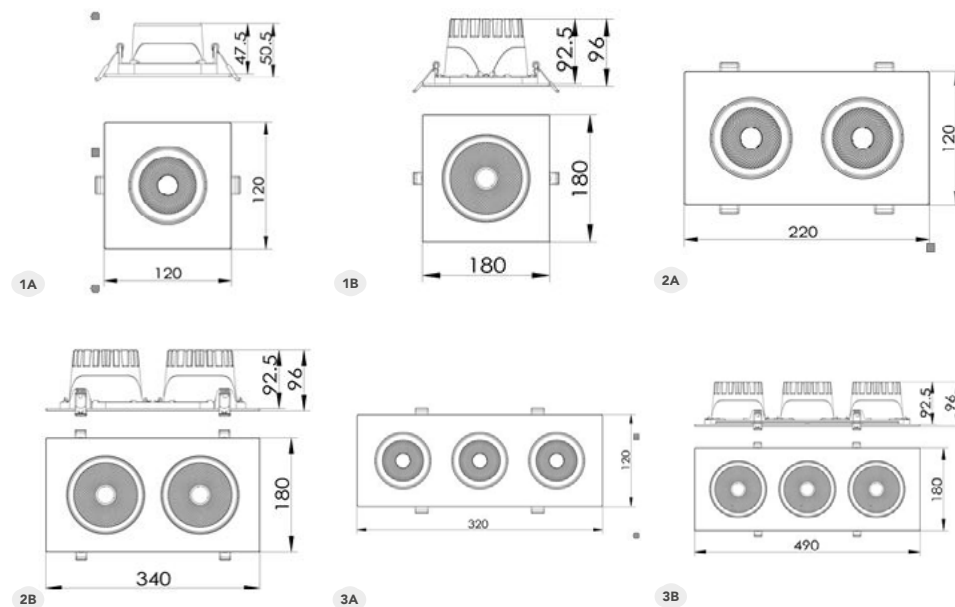

40°

DOWNLIGHT ROUND



Downlight DWC Round



REF	W	Lm	Color	Beam	Angle	Voltage	Beam Type	Beam Diameter
4 DWCB9982BC	10*	1050	3000K	BL	36°	0-10V	A24	
4 DWCB9975BF	10*	1100	4000K	BL	36°	0-10V	A24	
5 DWCB0001BC	16*	1990	3000K	BL	60°	0-10V	20	
5 DWCB9999BF	16*	2100	4000K	BL	60°	0-10V	A30	
1 DWCB0032BF	30*	3350	4000K	BL	45°	0-10V		D3
3 DWCB9968BC	8.8*	920	3000K	BL	36°	0-10V	A24	D4
3 DWCB9951BF	8.8*	970	4000K	BL	36°	0-10V	A24	D6
5 DWCB0025BC	20.8*	2400	3000K	BL	60°	0-10V	A20	
5 DWCB0018BF	20.8*	2500	4000K	BL	60°	0-10V	A30	
2 DWCB0049BF	40.8*	5100	4000K	BL	45°	0-10V	A24	

* Ver | see | vedere pg. 27

* Más opciones de W disponibles, consultar con un gestor de servicios de ROBLAN | Mais opções W disponíveis, consulte um gerente de serviço ROBLAN.
 * More W options available, consult with a ROBLAN service manager | Altre opzioni W disponibili, consultare un responsabile dell'assistenza ROBLAN.



Dimensiones | Dimensões | Dimensions | Dimensioni

1	H: 108 mm	Ø: 102 mm	0.03 kg	Ø: 90 mm	18
2	H: 116 mm	Ø: 145 mm	0.04 kg	Ø: 130 mm	8
3	H: 79 mm	Ø: 65 mm	0.08 kg	Ø: 55 mm	24
4	H: 84 mm	Ø: 75 mm	0.01 kg	Ø: 65 mm	24
5	H: 97 mm	Ø: 102 mm	0.015 kg	Ø: 90 mm	27

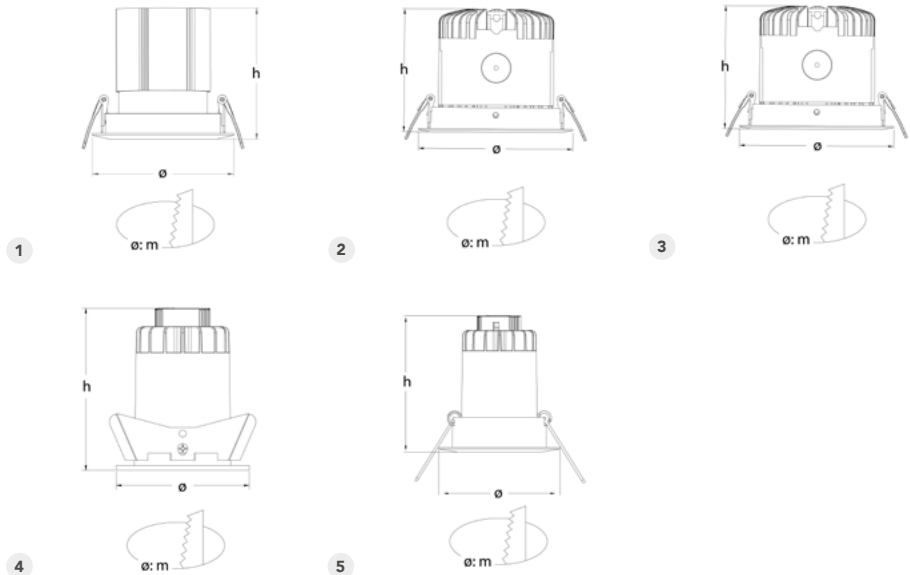
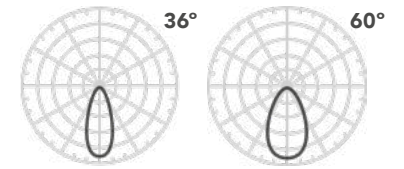

Accesorios | Acessórios | Accessories | Accessori





ROL



ROL



* Ver | see | vedere pg. 27

REF	W	Lm						
ROL4924BCCT	6.5	700 (2700K) - 780 (4100-6500K)	2700 / 4000 / 6500		□ BL	36°		

V AC220-240

Dimensiones | Dimensões | Dimensions | Dimensioni

H: 40 mm Ø: 105 mm 0.21 kg Ø: 87 mm 20

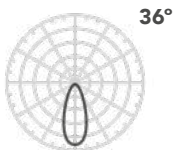

Unit: mm

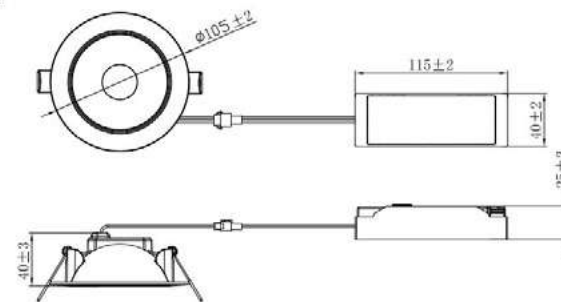

DOWNLIGHT DLC BAS



DOWNLIGHT DLC BAS



* Ver | see | vedere pg. 27

REF	W	Lm	Color	Beam	Angle	Control	Mount
3 DLCBAS15BC	15*	1450	3000K	BL	34°	0-10V	D3 D4 D6
3 DLCBAS15BF	15*	1500	4000K	BL	34°	0-10V	
1 DLCBAS25BC	24*	2300	3000K	BL	40°	0-10V	
1 DLCBAS25BF	24*	2300	4000K	BL	40°	0-10V	
2 DLCBAS40BC	40*	3900	3000K	BL	40°		
2 DLCBAS40BF	40*	4000	4000K	BL	40°		
2 DLCBAS40BB	40*	4000	6500K	BL	40°		

* Más opciones de W disponibles, consultar con un gestor de servicios de ROBLAN | Mais opções W disponíveis, consulte um gerente de serviço ROBLAN.
 * More W options available, consult with a ROBLAN service manager | Altre opzioni W disponibili, consultare un responsabile dell'assistenza ROBLAN.



	Dimensiones	Dimensões	Dimensions	Dimensioni	
1	H: 115 mm	Ø: 140 mm	0.025 kg	Ø: 125-130 mm	12
2	H: 160 mm	Ø: 190 mm	1.7 kg	Ø: 170-175 mm	8
3	H: 70 mm	Ø: 89 mm	0.015 kg	Ø: 75-80 mm	48

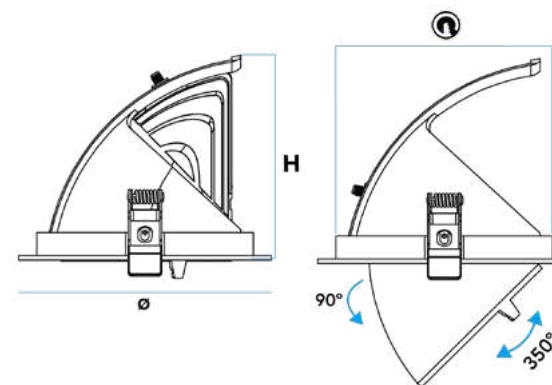
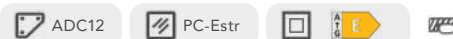
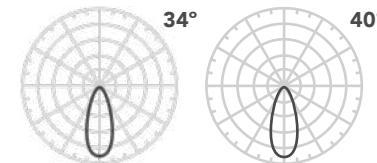



ALL IN PANEL



ALL IN PANEL

IP44 IK03 CRI80

* Ver | see | vedere pg. 27

REF	W	Lm	Color	Material	Beam	Dimmer	Socket
3 ALLINR2051BCC	6	500	3000K	BL	40°	TRIAC	E12
3 ALLINR2075NC	6	420	3000K	NG	40°	TRIAC	
3 ALLINR2044BFF	6	480	4000K	BL	40°	TRIAC	
3 ALLINR2068NF	6	420	4000K	NG	40°	TRIAC	
1 ALLINR2435BC	7	590	3000K	BL	90°	-	
1 ALLINR2428BF	7	640	4000K	BL	90°	-	
1 ALLINR2411BB	7	640	6000K	BL	90°	-	
2 ALLINR2466BC	14	1270	3000K	BL	90°	-	
2 ALLINR2459BF	14	1370	4000K	BL	90°	-	
2 ALLINR2442BB	14	1370	6000K	BL	90°	-	
4 ALLINR2497BC	25	2350	3000K	BL	90°	-	
4 ALLINR2480BF	25	2550	4000K	BL	90°	-	
4 ALLINR2473BB	25	2550	6000K	BL	90°	-	

V AC100-277 P.F. Max>0.9 -20°C ~ +40°C 20000 L70B50 30000h

Dimensiones | Dimensões | Dimensions | Dimensioni

Model	H: mm	Ø: mm	Weight: kg	Ø: mm	Quantity
1	63.5	92	0.09	68-80	60
2	75	145	0.19	120-130	32
3	79	81	0.18	68-73	60
4	94.5	244	0.58	195-210	16

Poliamida (Nylon) PC-Op

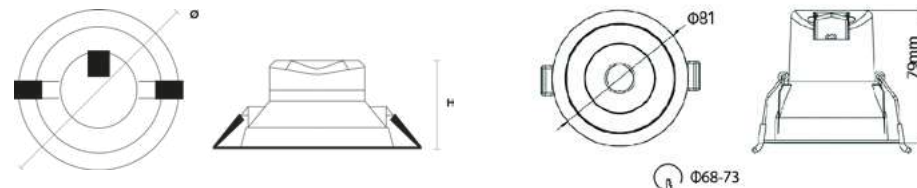
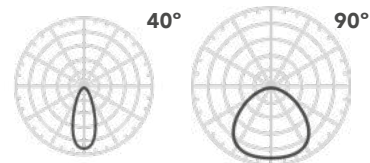

1 2 4

3





ALL IN O



PANEL SLIM CIRCULAR 30



ALL IN O

IP20 IK03 CRI80

* Ver | see | vedere pg. 27

REF	W	Lm	☀	🔌	^	Ⓜ
ALLINR0094BC	6.5	580	3000K	BL	40°	E12
ALLINR0117NC	6.5	580	3000K	NG	40°	
ALLINR0100BF	6.5	600	4000K	BL	40°	
ALLINR0124NF	6.5	600	4000K	NG	40°	

V AC220-240 P.F.>0.5 -20°C ~ +40°C 15000 L70B50 30000h

Dimensiones | Dimensões | Dimensions | Dimensioni

H: 43.8 mm Ø: 85 mm 0.07 kg Ø: 68-75 mm 60

Poliamida (Nylon) PS

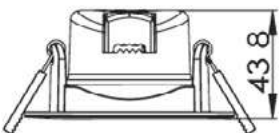
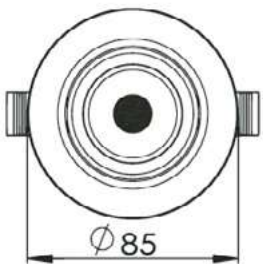
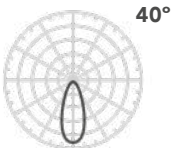

Ø68-75

PANEL SLIM CIRCULAR 30

IP20 CRI80 DALI

* Ver | see | vedere pg. 27

REF	W	Lm	☀	🔌	^	Ⓜ	Ⓜ
LEDPANEL30C	30	2300	3000K	BL	120°	D1 D3 D5	E16 E20 E22
LEDPANEL30F	30	2800	4000K	BL	120°		
LEDPANEL30B	30	2400	6500K	BL	120°		

V AC100-240 P.F.>0.9 -20°C ~ +40°C 12500

Dimensiones | Dimensões | Dimensions | Dimensioni

H: 22 mm Ø: 300 mm W: mm 0.26 kg Ø: 280 mm 20

Al PS-Op

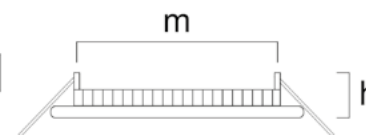
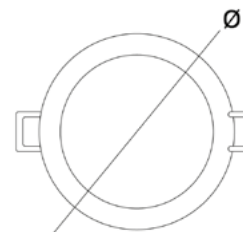
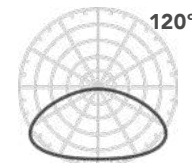



PANEL SLIM 18



PANEL SLIM 18



* Ver | see | vedere pg. 27

REF	W	Lm	Color	Beam	Beam	Beam	Beam
1 LEDPANEL18C	18*	1600	3000K	BL	120°	D1 D3 D6	E2 E10 E5 E13 E17 E20 E22
1 LEDPANEL18NIC	18*	1250	3000K	NS	120°		
1 LEDPANEL18CH	18*	1250	3000K	PL	120°		
1 LEDPANEL18F	18*	1650	4000K	BL	120°		
1 LEDPANEL18NIF	18*	1300	4000K	NS	120°		
1 LEDPANEL18HF	18*	1300	4000K	PL	120°		
1 LEDPANEL18B	18*	1700	6500K	BL	120°	D1 D2 D3 D4 D5 D6	
1 LEDPANEL18NIB	18*	1700	6500K	NS	120°		
1 LEDPANEL18H	18*	1350	6500K	PL	120°		
2 LEDPANELS18CB	18*	1600	3000K	BL	120°		
2 LEDPANELS18CNI	18*	1440	3000K	NS	120°		
2 LEDPANELS18FB	18*	1650	4000K	BL	120°		
2 LEDPANELS18FNI	18*	1300	4000K	NS	120°		
2 LEDPANELS18BB	18*	1700	6500K	BL	120°		
2 LEDPANELS18BNI	18*	1350	6500K	NS	120°		

* Más opciones de W disponibles, consultar con un gestor de servicios de ROBLAN | Mais opções W disponíveis, consulte um gerente de serviço ROBLAN.
 * More W options available, consult with a ROBLAN service manager | Altre opzioni W disponibili, consultare un responsabile dell'assistenza ROBLAN.



Dimensiones | Dimensões | Dimensions | Dimensioni

1	H: 22 mm Ø: 225 mm	0.337 kg	Ø: 205 mm	20
2	H: 22 mm L: 220 mm W: 220 mm	0.38 kg	205x205 mm	20

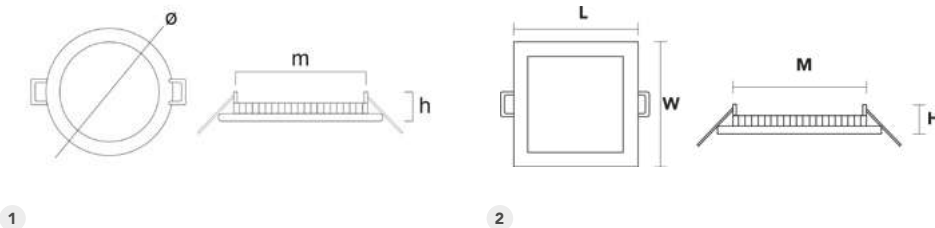
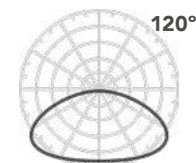



PANEL SLIM 12



PANEL SLIM 12



Dimensiones | Dimensões | Dimensions | Dimensioni

1	H: 22 mm Ø: 172 mm	0.235 kg	Ø: 153 mm	20
2	H: 22 mm L: 170 mm W: 170 mm	0.25 kg	155x155 mm	20

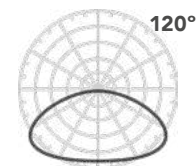

* Ver | see | vedere pg. 27

REF	W	Lm	Color	Beam	Beam Angle	Socket
1 LEDPANEL12C	12*	930	3000K	BL	120°	
2 LEDPANELS12CB	12*	930	3000K	BL	120°	
1 LEDPANEL12NIC	12*	780	3000K	NS	120°	
2 LEDPANELS12CNI	12*	830	3000K	NS	120°	
1 LEDPANEL12CH	12*	780	3000K	PL	120°	
1 LEDPANEL12FB	12*	950	4000K	BL	120°	
2 LEDPANELS12FB	12*	950	4000K	BL	120°	
1 LEDPANEL12NIF	12*	820	4000K	NS	120°	
2 LEDPANELS12FNI	12*	820	4000K	NS	120°	
1 LEDPANEL12HF	12*	820	4000K	PL	120°	
1 LEDPANEL12	12*	970	6500K	BL	120°	
2 LEDPANELS12BB	12*	970	6500K	BL	120°	
1 LEDPANEL12NIB	12*	820	6500K	NS	120°	
2 LEDPANELS12BNI	12*	820	6500K	NS	120°	
1 LEDPANEL12H	12*	820	6500K	PL	120°	

D1

D2

D3

D4

D5

D6

E2

E10

E5

E13

E17

E20

E22

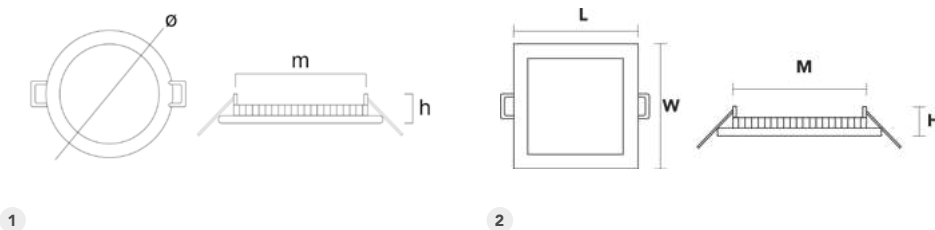

* Más opciones de W disponibles, consultar con un gestor de servicios de ROBLAN | Mais opções W disponíveis, consulte um gerente de serviço ROBLAN.
 * More W options available, consult with a ROBLAN service manager | Altre opzioni W disponibili, consultare un responsabile dell'assistenza ROBLAN.

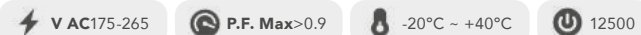



PANEL SLIM 6



PANEL SLIM 6



* Ver | see | vedere pg. 27

REF	W	Lm	Color	Beam	Angle	Buttons
1 LEDPANEL6CB	6*	460	3000K	BL	120°	
2 LEDPANELS6CB	6*	410	3000K	BL	120°	
1 LEDPANEL6NIC	6*	410	3000K	NS	120°	
2 LEDPANELS6CNI	6*	410	3000K	NS	120°	
1 LEDPANEL6FB	6*	470	4000K	BL	120°	
2 LEDPANELS6FB	6*	470	4000K	BL	120°	
1 LEDPANEL6NIF	6*	420	4000K	NS	120°	
2 LEDPANELS6FNI	6*	420	4000K	NS	120°	
1 LEDPANEL6BB	6*	480	6500K	BL	120°	
2 LEDPANELS6BB	6*	480	6500K	BL	120°	
1 LEDPANEL6NIB	6*	420	6500K	NS	120°	
2 LEDPANELS6BNI	6*	420	6500K	NS	120°	

- D1
- D2
- D3
- D4
- D5
- D6

- E12
- E2
- E10
- E5
- E13
- E17
- E20
- E22

* Más opciones de W disponibles, consultar con un gestor de servicios de ROBLAN | Mais opções W disponíveis, consulte um gerente de serviço ROBLAN.
 * More W options available, consult with a ROBLAN service manager | Altre opzioni W disponibili, consultare un responsabile dell'assistenza ROBLAN.



Dimensiones | Dimensões | Dimensions | Dimensioni

1	H: 22 mm Ø: 120 mm	0.145 kg	Ø: 105 mm	20
2	H: 22 mm L: 120 mm W: 120 mm	0.165 kg	105x105 mm	20

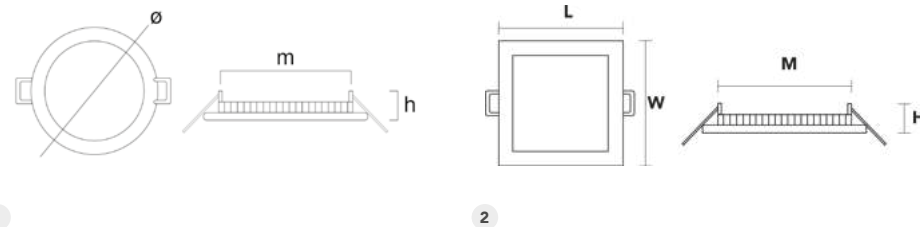
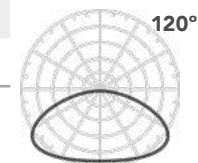



PANEL SLIM CIRCULAR 5



PANEL SLIM CIRCULAR 5



REF	W	Lm	Color	Beam	Angle	⌚	ⓔ
1 LEDPANEL5C	5*	380	3000K	BL	120°	D1 D2 D3 D4 D5 D6	E12 E2 E10 E5 E13 E17 E20 E22
2 LEDPANEL5NIC	5*	330	3000K	NS	120°		
2 LEDPANEL5HC	5*	330	3000K	PL	120°		
1 LEDPANEL5F	5*	340	4000K	BL	120°		
2 LEDPANEL5NIF	5*	340	4000K	NS	120°		
2 LEDPANEL5HF	5*	340	4000K	PL	120°		
1 LEDPANEL5B	5*	400	6500K	BL	120°		
1 LEDPANEL5NIB	5*	350	6500K	NS	120°		
2 LEDPANEL5HB	5*	350	6500K	PL	120°		

* Ver | see | vedere pg. 27

* Más opciones de W disponibles, consultar con un gestor de servicios de ROBLAN | Mais opções W disponíveis, consulte um gerente de serviço ROBLAN.
 * More W options available, consult with a ROBLAN service manager | Altre opzioni W disponibili, consultare un responsabile dell'assistenza ROBLAN.



⊗ Dimensiones | Dimensões | Dimensions | Dimensioni

1	H: 22 mm	Ø: 90 mm	W: mm	0.06 kg	Ⓜ Ø: 72 mm	80
2	H: 9 mm	Ø: 90 mm	W: mm	0.06 kg	Ⓜ Ø: 72 mm	100

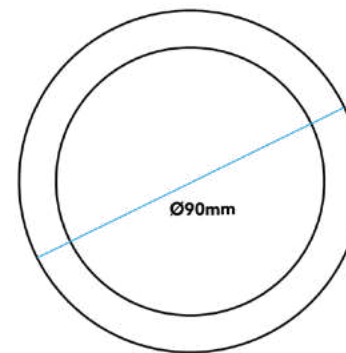
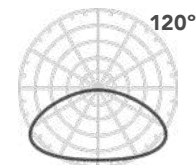



PANEL D CIRCULAR



PANEL D CIRCULAR

IP20 IK02 CRI80

REF	W	Lm	Color	Beam	Angle
1 DPANEL6C	6	410	3000K	BL	120°
1 DPANEL6F	6	470	4000K	BL	120°
1 DPANEL6B	6	430	6500K	BL	120°
2 DPANEL12C	12	890	3000K	BL	120°
2 DPANEL12F	12	900	4000K	BL	120°
2 DPANEL12B	12	780	6500K	BL	120°
3 DPANEL18C	18	1600	3000K	BL	120°
3 DPANEL18F	18	1650	4000K	BL	120°
3 DPANEL18B	18	1700	6500K	BL	120°

V AC100-240 P.F.>0.5 -20°C ~ +40°C 12500 L7050 54000h

Dimensiones | Dimensões | Dimensions | Dimensioni

	H: 22 mm	Ø: 120 mm	0.105 kg	Ø: 100 mm	20
1					
2		Ø: 172 mm	0.175 kg	Ø: 153 mm	20
3		Ø: 225 mm	0.29 kg	Ø: 200 mm	20

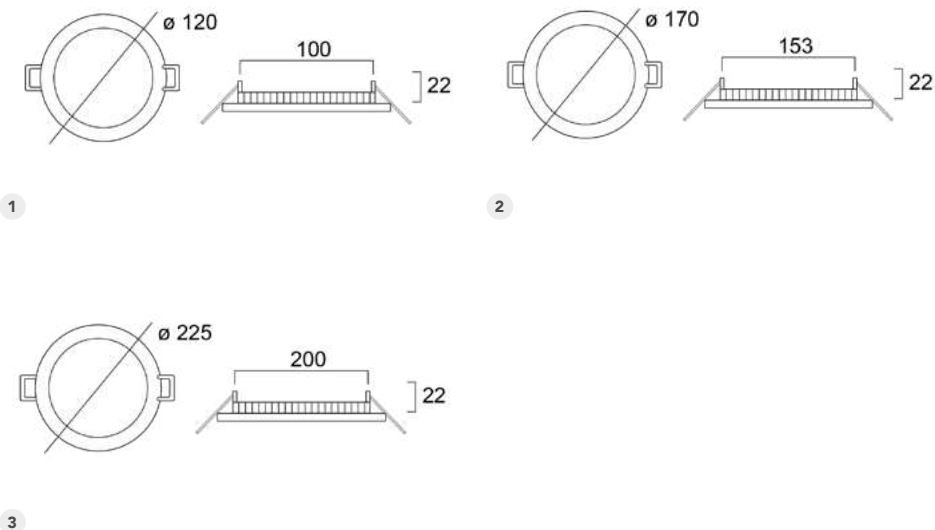
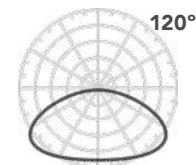



ADJUSTABLE PANEL

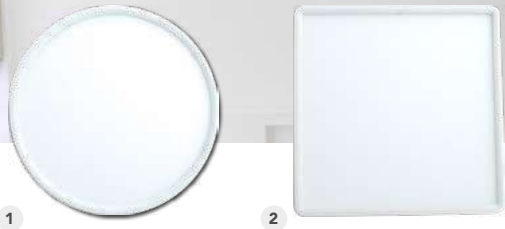

1

2

ADJUSTABLE PANEL



* Ver | see | vedere pg. 5

REF	W	Lm	Color	Beam	Angle	Options
1 AJPANELR20C	20*	2200	3000K	BL	120°	D1, E2
2 AJPANELS20C	20*	1900	3000K	BL	120°	D2, E5
2 AJPANELS20F	20*	1950	4000K	BL	120°	D3, E10
2 AJPANELS20B	20*	2000	6500K	BL	120°	D4, E13
						D5, E17
						D6, E22

* Más opciones de W disponibles, consultar con un gestor de servicios de ROBLAN | Mais opções W disponíveis, consulte um gerente de serviço ROBLAN.
 * More W options available, consult with a ROBLAN service manager | Altre opzioni W disponibili, consultare un responsabile dell'assistenza ROBLAN.

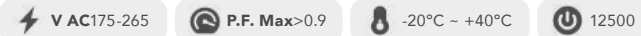

Dimensiones | Dimensões | Dimensions | Dimensioni

H: 22 mm Ø: 230 mm 0.26 kg Ø: 50-200 mm 30

H: 22 mm Ø: 230 mm W: 230 mm 0.26 kg Ø: 50-200 mm 30

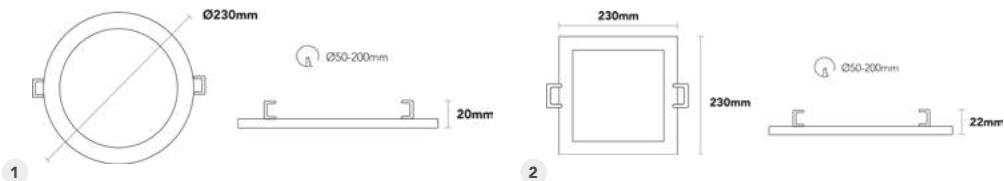
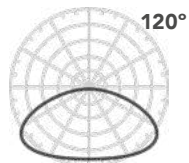

AJ PANEL V2



AJ PANEL V2



REF	W	Lm	Color	Beam	Angle
1 AJPANELV220CCT	20	1800	3000 / 4000 / 5700	BL	110°
2 AJPANELV228CCT	15 - 22 - 28	15W:1200-1400Lm / 22W:1800-2000Lm / 28W:2300-2500Lm	3000 / 4000 / 5700	BL	110°

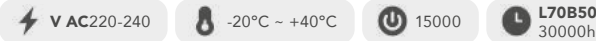

Dimensiones | Dimensões | Dimensions | Dimensioni

1 H: 18 mm Ø: 220 mm 0.35 kg Ø: 65-205 mm 20

2 H: 24.7 mm Ø: 336 mm 0.38 kg Ø: 65-310 mm 10

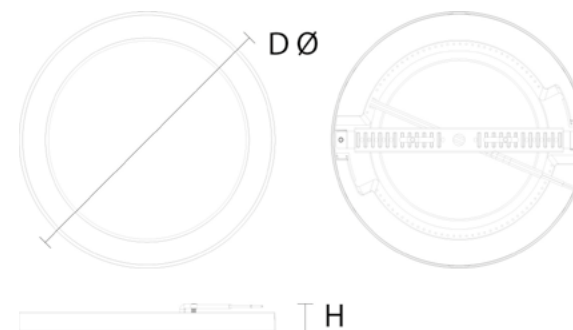
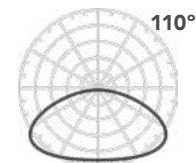



PANEL RR



PANEL RR



REF	W	Lm			
LEDPANELRR18FB	18	1620	■ 4000K	□ BL	120°



Dimensiones | Dimensões | Dimensions | Dimensioni

H: 16 mm Ø: 225 mm W: mm 0.36 kg 40

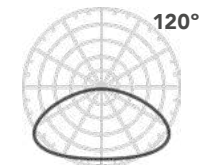

ACCESS PANEL RR

FRAMESRR18



Accesorio para panel de superficie LEDPANELRR18FB
| Accessory for Surface mounting LEDPANELRR18FB

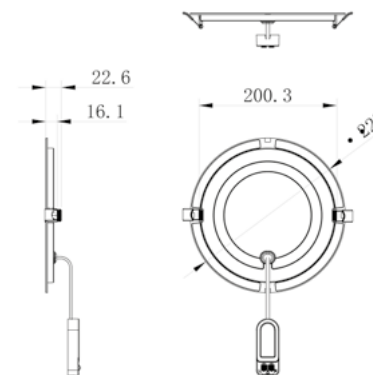



1

2

MOON

IP44 IK03 CRI80

REF	W	Lm	Color	Beam	Angle
1A MOONS2589BC	11	800	3000K	BL	110°
2A MOONR2527BC	11	780	3000K	BL	110°
1A MOONS2572BF	11	830	4000K	BL	110°
2A MOONR2510BF	11	850	4000K	BL	110°
1A MOONS2565BB	11	870	6000K	BL	110°
2A MOONR2503BB	11	860	6000K	BL	110°
1B MOONS2619BC	18	1460	3000K	BL	110°
2B MOONR2558BC	18	1350	3000K	BL	110°
1B MOONS2602BF	18	1500	4000K	BL	110°
2B MOONR2541BF	18	1450	4000K	BL	110°
1B MOONS2596BB	18	1550	6000K	BL	110°
2B MOONR2534BB	18	1450	6000K	BL	110°

V AC100-277 P.F. Max>0.9 -20°C ~ +40°C 20000 L70B50 55000h

Dimensiones | Dimensões | Dimensions | Dimensi

1A	H: 35 mm L: 172 mm W: 172 mm 0.4 kg	120 mm	36
1B	H: 39 mm L: 231 mm W: 231 mm 0.6 kg	174 mm	40
2A	H: 39 mm Ø: 182 mm 0.35 kg	Ø: 120 mm	36
2B	H: 39 mm Ø: 232 mm 0.5 kg	Ø: 170 mm	28

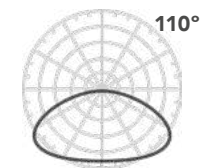

110°

PC PS-Op

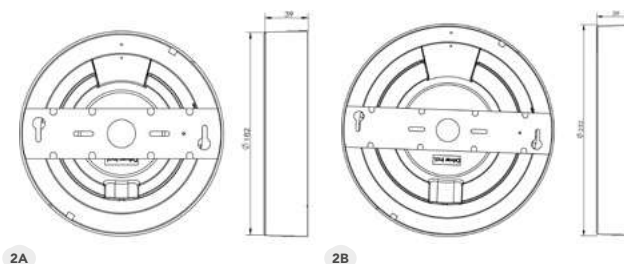
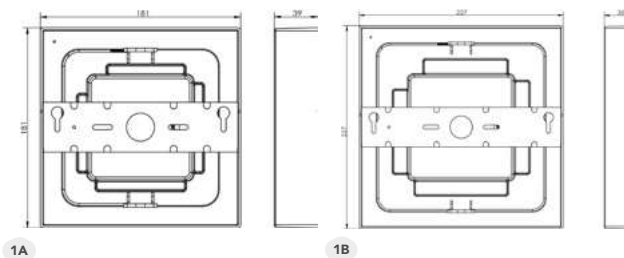

PANEL SURFACE 6



1

2

PANEL SURFACE 6



* Ver | see | vedere pg. 27

REF	W	Lm	Color	Beam	Temp	Options
1 LPANELS56C	6*	460	3000K	BL	120°	D1 D2 D3 D4 D5 D6
2 LPANELSR6C	6*	410	3000K	BL	120°	
2 LPANELSR6F	6*	420	4000K	BL	120°	
1 LPANELS56F	6*	470	4100K	BL	120°	
1 LPANELS56B	6*	480	6500K	BL	120°	
2 LPANELSR6B	6*	420	6500K	BL	120°	

* Más opciones de W disponibles, consultar con un gestor de servicios de ROBLAN | Mais opções W disponíveis, consulte um gerente de serviço ROBLAN.
 * More W options available, consult with a ROBLAN service manager | Altre opzioni W disponibili, consultare un responsabile dell'assistenza ROBLAN.

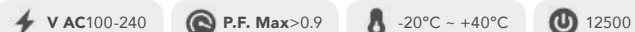

Dimensiones | Dimensões | Dimensions | Dimensioni

1	H: 32 mm	L: 120 mm	W: 120 mm	0.2 kg	20
2	H: 35 mm	Ø: 120 mm		0.16 kg	20

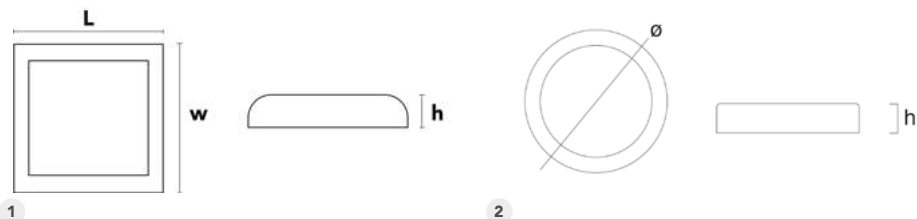
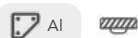

1

2

PANEL SUPERFICIE CIRCULAR 30



Panel Superficie Circular 30



* Ver | see | vedere pg. 27

REF	W	Lm	Color	Beam	Temp	Options
LPANELSR30C	30*	2300	3000K	BL	120°	D1 D2 D3 D4 D5 D6
LPANELSR30F	30*	2800	4000K	BL	120°	
LPANELSR30B	30*	2850	6500K	BL	120°	

* Más opciones de W disponibles, consultar con un gestor de servicios de ROBLAN | Mais opções W disponíveis, consulte um gerente de serviço ROBLAN.
 * More W options available, consult with a ROBLAN service manager | Altre opzioni W disponibili, consultare un responsabile dell'assistenza ROBLAN.



Dimensiones | Dimensões | Dimensions | Dimensioni

H: 35 mm Ø: 300 mm 0.7 kg 20

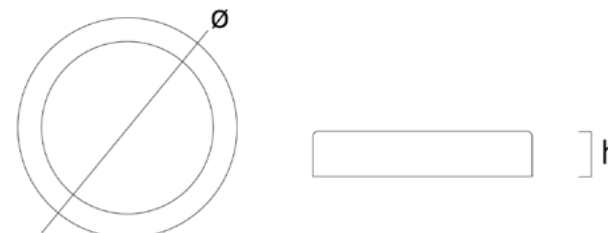
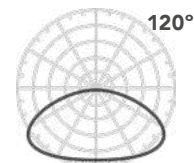



1

2

PANEL SURFACE 12 - 18



* Ver | see | vedere pg. 27

REF	W	Lm	Color	Beam	Angle	
1A LPANELSS12C	12*	780	3000K	BL	120°	D1 D2 D3 D4 D5 D6
2A LPANELSR12C	12*	930	3000K	BL	120°	
1A LPANELSS12F	12*	950	4000K	BL	120°	
2A LPANELSR12F	12*	950	4000K	BL	120°	
1A LPANELSS12B	12*	820	6500K	BL	120°	
2A LPANELSR12B	12*	970	6500K	BL	120°	
1B LPANELSS18C	18*	1250	3000K	BL	120°	
2B LPANELSR18C	18*	1600	3000K	BL	120°	
1B LPANELSS18F	18*	1650	4000K	BL	120°	
2B LPANELSR18F	18*	1650	4000K	BL	120°	
1B LPANELSS18B	18*	1700	6500K	BL	120°	
2B LPANELSR18B	18*	1700	6500K	BL	120°	

* Más opciones de W disponibles, consultar con un gestor de servicios de ROBLAN | Mais opções W disponíveis, consulte um gerente de serviço ROBLAN.
 * More W options available, consult with a ROBLAN service manager | Altre opzioni W disponibili, consultare un responsabile dell'assistenza ROBLAN.

- V AC100-240
- P.F. Max>0.9
- 20°C ~ +40°C
- 12500



Dimensiones | Dimensões | Dimensions | Dimensioni

Model	H	L	W	Weight	Qty
1A	32 mm	170 mm	170 mm	0.28 kg	20
1B	32 mm	220 mm	220 mm	0.43 kg	20
2A	35 mm	Ø: 170 mm		0.26 kg	20
2B	35 mm	Ø: 225 mm		0.43 kg	20

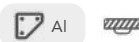
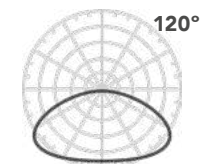

1

4

Flip[®]

downlight



Downlight empotrable técnico

Downlight embutido técnico
Technical recessed downlight
Downlight incasso tecnico

diseño estético y elegante con variedad de opciones

Design estético e elegante com variedade de opções
aesthetic and elegant with wide range of options
Design estetico ed elegante con una varietà di opzioni

LED FLIP DOWNLIGHT

DATOS TÉCNICOS.



DADOS TÉCNICOS | TECHNICAL DATA | DATI TECNICI

- W** 5W | 8W | 10W | 12W | 15W
- Lm** 500Lm | 800Lm | 1000Lm | 1200Lm | 1500Lm
- ⚡** AC220-240V
- 🌀** >90
- 🕒** Dimmable 0-10
Non-Dimmable
- 📐** 28° | 38° | 55°
- 🌞** 2700K - 3000K - 4000K - 5000K
- 📏** Redonda | Cuadrada / Simétrica | Asimétrica
Redonda | Cuadrada / Simétrica | Asimétrica
Round | Square / Flat | Wash
Rotonda | Quadrata / Simmetrica | Asimmetrica
- 💧** IP44 Nivel de difusor. Installed IP
- ⌚** 50.000h
- 🛡️** 02



FLIP REDONDO. ROUND



FLIP CUADRADO. SQUARE



Arma tu FLIP | Construa o seu FLIP | Build your FLIP | Costruisci il tuo FLIP

1 Paso | Passo | Step FORMATO ARO | FORMATO ANEL | RING FORMAT | FORMATO ANELLO

FLIP REDONDO. ROUND



Round Flat 90mm
FLIPRF90



Round Flat 75mm
FLIPRF75



Round Wash 90mm
FLIPRW90



Round Wash 75mm
FLIPRW75



FLIP CUADRADO. SQUARE



Square Flat 90mm
FLIPSF90



Square Flat 75mm
FLIPSF75



Square Wash 90mm
FLIPSW90

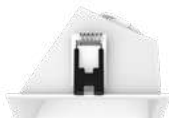

Square Wash 75mm
FLIPSW75



2 Paso | Passo | Step COLOR ARO | COR DO ARO | RING COLOR | COLORE DELL'ANELLO

BL

FLIPXXXXBB



BL ■ NG

FLIPXXXXBN



PL

FLIPXXXXBS



■ NG

FLIPXXXXNN



Otros colores
Other Colors
Consulte con su comercial
Contact your sales rep.



Paso 1 Step 1 Passo 1
EJEMPLO REFERENCIA ARO
EXEMPLO DE REFERÊNCIA DO ARO
RING ITEM CODE EXAMPLE
ESEMPIO DI RIFERIMENTO DELL'ANELLO

FLIPRF90BS
ARO FLIP REDONDO BLANCO / PLATA 90MM
ARO FLIP REDONDO BRANCO / PRATA 90MM
RING FOR FLIP ROUND WHITE / SILVER 90MM
ANELLO FLIP ROTONDO BIANCO / ARGENTO 90MM

Arma tu FLIP | Construa o seu FLIP | Build your FLIP | Costruisci il tuo FLIP

2.1 Paso | Passo | Step POTENCIA SISTEMA (CON CUERPO BLANCO). ENGINE POWER (WHITE BODY)

W Lm 5W-500Lm **FLIP5** 8W-800Lm **FLIP8** 10-1000Lm **FLIP10** 12-1200Lm **FLIP12** 15-1500Lm **FLIP15**



2.2 Paso | Passo | Step KELVIN. KELVINS

2700K **FLIPXWWB** 3000K **FLIPXWB** 4000K **FLIPXFB** 5000K **FLIPXBB**

MEDIDAS AROS + CUERPO SISTEMA.
MEDIDAS AROS + CORPO DO SISTEMA
RING + ENGINE MEASUREMENTS
MISURE ANELLI + CORPO DEL SISTEMA

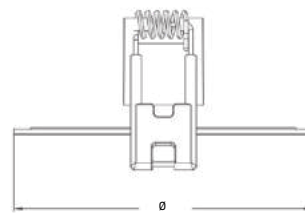

FLIP	●	■
75	Ø82	82*82
90	Ø98	98*98

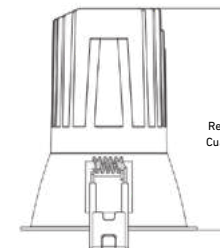

FLIP	5W-8W	10W-12W-15W
75	h:80	h:100
90	h:103	h:123

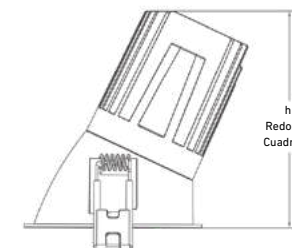

FLIP	5W-8W	10W-12W-15W
75	h:80	h:100
90	h:100	h:120

Paso 2 Step 2 Passo 2
EJEMPLO REFERENCIA ARO
EXEMPLO DE REFERÊNCIA DO ARO
RING ITEM CODE EXAMPLE
ESEMPIO DI RIFERIMENTO DELL'ANELLO

FLIP15BB
SISTEMA DE DOWINGLIGHT FLIP 15W 1500LM 5000K
CUERPO BLANCO
SISTEMA DE DOWNLIGHT FLIP 15W 1500LM 5000K CORPO BRANCO
FLIP DOWNLIGHT SYSTEM 15W 1500LM 5000K WHITE BODY
SISTEMA DOWNLIGHT FLIP 15W 1500LM 5000K CORPO BIANCO

 Arma tu FLIP | Construa o seu FLIP | Build your FLIP | Costruisci il tuo FLIP

3 Paso | Passo | Step DRIVER

 Dimmable 0-10
Non-Dimmable

 AC220-240V

5-12 W DIM 0-10 TRIAC
FLIPDRIVER512D

15W DIM 0-10 TRIAC
FLIPDRIVER15D

5W NON DIM
FLIPDRIVER5

8-15W NON DIM
FLIPDRIVER815

4 Paso | Passo | Step ÂNGULOS DE APERTURA | ÂNGULOS DE ABERTURA | LIGHT | ANGOLI DI APERTURA

 28° | 38° | 55°

55°
FLIPR6

38°
FLIPR4

28°
FLIPR2



FLIPRF90BS + FLIP15BB + FLIPDRIVER815+ FLIPR6

FLIP REDONDO 15W 55° 1500LM 5000K NO DIM BLANCO / PLATA 90MM
FLIP REDONDO 15W 55° 1500LM 5000K NÃO DIM BRANCO / PRATA 90MM
ROUND FLIP 15W 55° 1500LM NON DIM WHITE / SILVER 90MM
FLIP TONDO 15W 55° 1500LM 5000K NON DIMMABILE BIANCO / ARGENTO 90MM



**Paso 1-4
Step 1-4
Passo 1-4**

EJEMPLO REFERENCIA ARO
EXEMPLO DE REFERÊNCIA DO ARO
RING ITEM CODE EXAMPLE
ESEMPIO DI RIFERIMENTO DELL'ANELLO

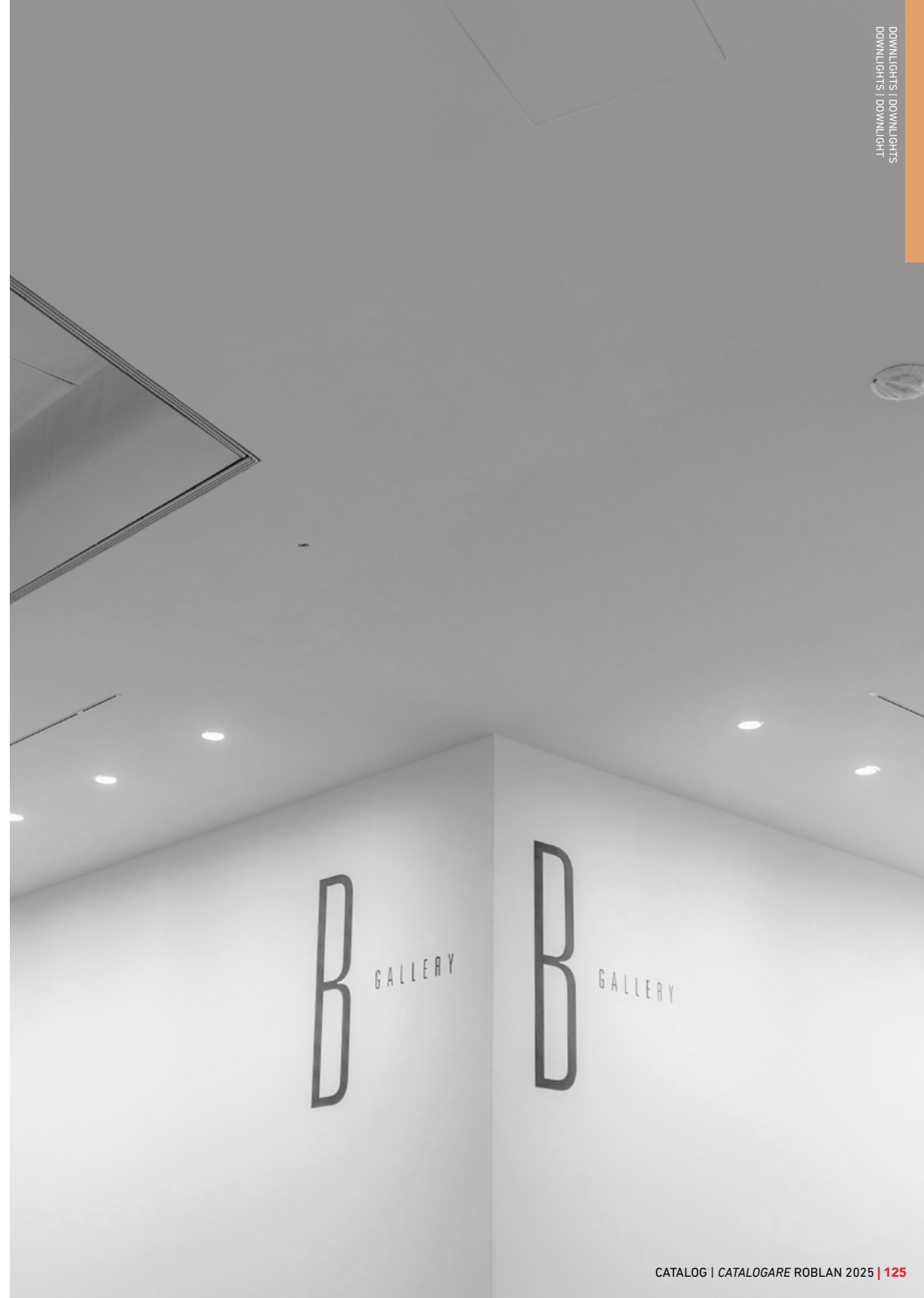

TROCO ACCESS S

TROCOSQ10B



Tapa Blanca Cuadrada para Downlight TROCO 110/210 | Capa Branca Quadrada para Downlight TROCO 110/210 | White Square Cover for TROCO 110/210 Downlight | Cover Quadrata Bianca per Downlight TROCO 110/210

□ BL

TROCOSQ15B



Tapa Blanca Cuadrada para Downlight TROCO 115/215 | Capa Branca Quadrada para Downlight TROCO 115/215 | White Square Cover for TROCO 115/215 Downlight | Cover Quadrata Bianca per Downlight TROCO 115/215

□ BL

TROCOSQ20B



Tapa Blanca Cuadrada para Downlight TROCO 120/220 | Capa Branca Quadrada para Downlight TROCO 120/220 | White Square Cover for TROCO 120/220 Downlight | Cover Quadrata Bianca per Downlight TROCO 120/220

□ BL

TROCOSQ10N



Tapa Negra Cuadrada para Downlight TROCO 110/210 | Capa preta quadrada para downlight TROCO 110/210 | Black Square Cover for TROCO 110/210 Downlight | Cover Quadrata Nera per Downlight TROCO 110/210

■ NG

TROCOSQ15N



Tapa Negra Cuadrada para Downlight TROCO 115/215 | Capa preta quadrada para downlight TROCO 115/215 | Black Square Cover for TROCO 115/215 Downlight | Cover Quadrata Nera per Downlight TROCO 115/215

■ NG

TROCOSQ20N



Tapa Negra Cuadrada para Downlight TROCO 120/220 | Capa preta quadrada para downlight TROCO 120/220 | Black Square Cover for TROCO 120/220 Downlight | Cover Quadrata Nera per Downlight TROCO 120/220

■ NG

TROCO SURF

TROCOSURF15W



Accesorio superficie para modelos TROCO 150mm Blanco | Acessório de superfície para modelos TROCO 150mm Branco | Surface kit for TROCO 150mm White | Accessorio di superficie per modelli TROCO 150mm Bianco

□ BL

TROCOSURF15N



Accesorio superficie para modelos TROCO 150mm Negro | Acessório de superfície para modelos TROCO 150mm Preto | Surface kit for TROCO 150mm Black | Accessorio di superficie per modelli TROCO 150mm Nero

■ NG

TROCOSURF20W



Accesorio superficie para modelos TROCO 200mm Blanco | Acessório de superfície para modelos TROCO 200mm Branco | Surface kit for TROCO 200mm White | Accessorio di superficie per modelli TROCO 200mm Bianco

□ BL

TROCO ACCES R

TROCORD10N



Tapa Negra Redonda para Downlight TROCO 110/210 | Capa preta redonda para downlight TROCO 110/210 | Black Round Cover for TROCO 110/210 Downlight | Cover Tonda Nera per Downlight TROCO 110/210

■ NG

TROCORD15N



Tapa Negra Redonda para Downlight TROCO 115/215 | Capa preta redonda para downlight TROCO 115/215 | Black Round Cover for TROCO 115/215 Downlight | Cover Tonda Nera per Downlight TROCO 115/215

■ NG

TROCORD20N



Tapa Negra Redonda para Downlight TROCO 120/220 | Capa preta redonda para downlight TROCO 120/220 | Black Round Cover for TROCO 120/220 Downlight | Cover Tonda Nera per Downlight TROCO 120/220

■ NG

TROCORD10C



Tapa Redonda con Cristal para Downlight TROCO 110/210 | Tampa Redonda com Vidro para Downlight TROCO 110/210 | Round Glass module Cover for TROCO 110/210 Downlight | Copertura Tonda con Vetro per Downlight TROCO 110/210

TROCORD15C



Tapa Redonda con Cristal para Downlight TROCO 115/215 | Tampa Redonda com Vidro para Downlight TROCO 115/215 | Round Glass module Cover for TROCO 115/215 Downlight | Copertura Tonda con Vetro per Downlight TROCO 115/215

TROCORD20C



Tapa Redonda con Cristal para Downlight TROCO 120/220 | Tampa Redonda com Vidro para Downlight TROCO 120/220 | Round Glass module Cover for TROCO 120/220 Downlight | Copertura Tonda con Vetro per Downlight TROCO 120/220

TROCO SURF

TROCOSURF20N



Accesorio superficie para modelos TROCO 200mm Negro | Acessório de superfície para modelos TROCO 200mm Preto | Surface kit for TROCO 200mm Black | Accessorio di superficie per modelli TROCO 200mm Nero

■ NG

 **DWC Difusor**

DWCR20



Difusor 20° para Downlight Circular COB 16W & 21W | Difusor 20° para Downlight Circular COB 16W & 21W | Reflector 20° for Round Downlight COB 16w & 21W | Diffusore da 20° per faretti circolari COB da 16W e 21W

DWCR24



Difusor 24° para Downlight Circular COB 9W & 10W | Difusor de 24° para Downlight circular COB de 9W e 10W | Reflector 24° for Round Downlight COB 9w & 10W | Diffusore a 24° per downlight circolare COB da 9W e 10W

DWCR2441



Difusor 24° para Downlight Circular COB 41W | Difusor 24° para Downlight Circular COB 41W | Reflector 24° for Round Downlight COB 41W | Diffusore 24° per Downlight Circolare COB 41W

 **ACCESS VERSA**

DWCR30



Difusor 30° para Downlight Circular COB 16W & 21W | Difusor 30° para Downlight Circular COB 16W & 21W | Reflector 24° for Round Downlight COB 16w & 21W | Diffusore a 30° per faretti circolari COB da 16W e 21W

RING20SENSN / RING20SENS



Aro decorativo negro / plata 220mm Diam. para VERSA4931BCCTS | | Decorative Trim Black / silver 220mm Diameter for VERSA4931BCCTS |

NG PL

RING30SENSN / RING30SENS



Aro decorativo negro / plata 330mm Diam. para VERSA4948BCCTMPS | | Decorative Trim Black / Silver 330mm Diameter for VERSA4948BCCTMPS |

NG PL

 **DOWNL ACCESS**

AROBDL18W



ARO CUBRE HUECO P/DOWNL.BL 18W d.255 BL | ANEL DE COBERTURA OCO PARA DOWNL.BL 18W d.255 BL | RING COVERS HOLLOW P / DOWNL. BL 18W d.255 BL | ANELLO COPERCHIO CAVO PER DOWNL.BL 18W d.255 BL

BL

AROBDL24W



ARO CUBRE HUECO P/DOWNL. BL 24W Diámetro 205 mm | RING TAMP HOLLOW PARA DOWNL. BL 24W Diámetro 205 mm | RING COVERS HOLLOW P / DOWNL. BL 24W d.205mm | COPERCHIO ANELLO CAVO PER DOWNL. BL 24W Diámetro 205 mm

BL



DOWNLIGHTS | DOWNLIGHTS