

SISTEMAS LINEALES

Sistemas lineares | Linear systems | Sistemi lineari

SISTEMAS LINEALES | SISTEMAS LINEARES
LINEAR LIGHTING SYSTEMS | SISTEMI DI
ILLUMINAZIONE LINEARE

La luz necesita algo más que existir.

Un Lightfluencer le da propósito.



Apúntate a nuestra Masterclass



MODEL	GAMA	W	Lm W														
V SET 60	LED	27 36	125			100°	CRI80	IP20	0-10V *D3, D4, D5, D6	220-240V AC	P.F≥0.95		H: 85 mm W: 60 mm L: 1200 mm L: 900 mm	D-Prism	IK10		PG 180
V SET 60 SHAPE	LED	36	125			100°	CRI	IP20	0-10V *D3, D4, D5, D6	220-240V AC	P.F≥0.95		H: 583 mm H: 598 mm W: 60 mm L: 583 mm L: 598 mm	D-Prism	IK10		PG 181
SET S	LED	15	100			120° 95°	CRI90	IP20	0-10V	220-240V AC	P.F≥0.9		H: 82 mm W: 62 mm L: 575 mm	Estr Op	IK08		PG 188
SET M	LED	22	100			120° 95°	CRI90	IP20	0-10V	220-240V AC	P.F≥0.9		H: 82 mm W: 62 mm L: 855 mm	Estr Op	IK08		PG 189
SET L	LED	30	100			120° 95°	CRI90	IP20	0-10V	220-240V AC	P.F≥0.9		H: 82 mm W: 62 mm L: 1135 mm	Estr Op	IK08		PG 189
SET A	LED	30	100			120° 95°	CRI90	IP20	0-10V	220-240V AC	P.F≥0.9		H: 82 mm W: 62 mm L: 580 mm	Estr Op	IK08		PG 190
LCR	LED	40 50 60 70*	171			90°	CRI80	IP20	*D1, D3, D6	100-277V AC	P.F≥0.95		H: 39,4 mm W: 69,8 mm L: 1200 mm L: 1500 mm	PMMA Op	IK05		PG 194
V SET	LED	23 27 30	130			80° 90°	CRI80	IP20	0-10V *D16, D6	200-240V AC	P.F≥0.95		H: 72 mm W: 50 mm L: 1130 mm L: 850 mm	D-Prism Ref	IK08		PG 198
RV SET	LED	23 30	130			110° 90°	CRI80	IP20	0-10V *D3, D4, D5, D6	220-240V AC	P.F≥0.95		H: 33 mm W: 62,5 mm L: 1144 mm L: 860 mm	Polycarbonato Ref	IK08		PG 202

V SET 60 LINEAL



V SET 60

- IP20
- IK10
- CRI80
- DALI
- PIR

* Ver | see | vedere pg. 27

REF	W	Lm	Ø	□	△	⊙	⊙	⊙
1 VSETD6090B	27	2875	3000 4000 5700	BL	100°	0-10V	D3	E2 E5
1 VSETD6090N	27	2875	3000 4000 5700	NG	100°	0-10V	D4	E13 E22
2 VSETD60120B	36	4500	3000 4000 5700	BL	100°	0-10V	D5	E5 E13
2 VSETD60120N	36	4500	3000 4000 5700	NG	100°	0-10V	D6	E22

- V AC220-240
- 20°C ~ +40°C
- L7050 54000h
- >>> CCT

Dimensiones | Dimensões | Dimensions | Dimensioni

1	H: 85 mm	L: 1200 mm	W: 60 mm	2.8 kg	6
2	H: 85 mm	L: 900 mm	W: 60 mm	2.16 kg	6

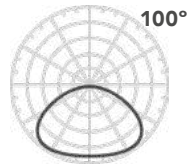

- Al + PMMA
- D-Prism
-
- A C
- ⊘
- ⊘
- ⊘

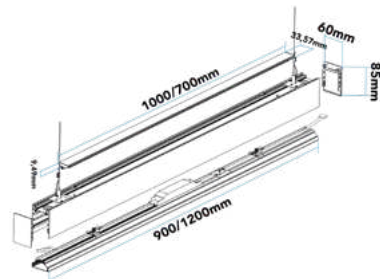

V SET 60 SHAPE



V SET 60 SHAPE

- IP20
- IK10
- DALI
- PIR

* Ver | see | vedere pg. 27

REF	W	Lm	Ø	□	△	⊙	⊙	⊙
3 VSET60120XBONLIG	36	4500	3000 4000 5700	BL	100°	0-10V	D3	E5
3 VSET60120XNCONLIG	36	4500	3000 4000 5700	NG	100°	0-10V	D4	E13 E22
4 VSET60120TBONLIG	36	4500	3000 4000 5700	BL	100°	0-10V	D5	E5 E13
4 VSET60120TNCONLIG	36	4500	3000 4000 5700	NG	100°	0-10V	D6	E22
5 VSET60120LNONLIG	36	4500	3000 4000 5700	NG	100°	0-10V	D3	E5
5 VSET60120LBONLIG	36	4500	3000 4000 5700	BL	100°	0-10V	D4	E13

- V AC220-240
- 20°C ~ +40°C
- L7050 54000h
- >>> CCT

Dimensiones | Dimensões | Dimensions | Dimensioni

3	H: 583 mm	L: 583 mm	W: 60 mm	3.8 kg
4	H: 598 mm	L: 583 mm	W: 60 mm	2.8 kg
5	H: 598 mm	L: 598 mm	W: 60 mm	3.03 kg

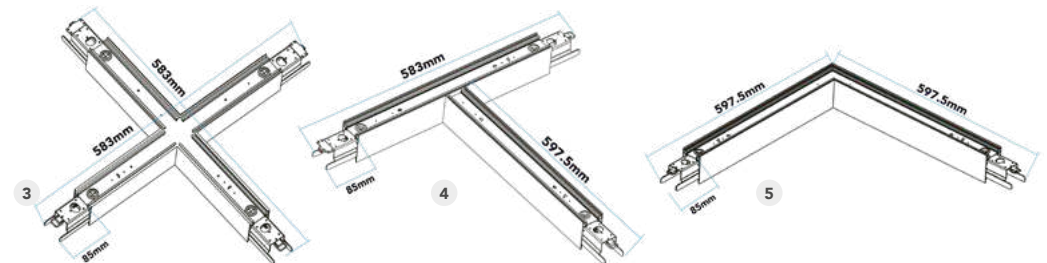
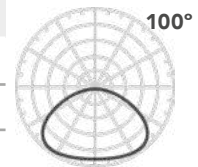

V SET 60

Ideas de instalaciones
Installation ideas
Ideias de instalações
Idee per installazioni

Cuadrícula en suspensión
Grade em suspensão
Suspended grid | Griglia sospesa (SHAPE L + T + X)

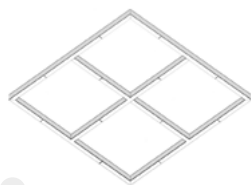

1

Cruz en techo | Roof Cross
Cruz no teto | Croce sul soffitto
(SHAPE L)

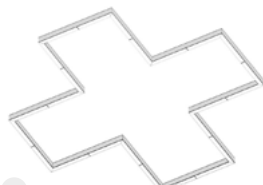

2

Cuadrado en suspensión | Square in suspension
Quadrado em suspensão
Quadrato in sospensione (SHAPE L)

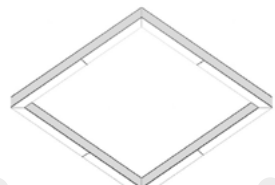

3

T invertida | Inverted T
T invertido | T invertita
(V SET 60 + SHAPE T)



4

Cuadrados abiertos en suspensión
Quadrados abertos em suspensão
Open squares in suspension
Quadrati aperti in sospensione (SHAPE L)



5

L & L invertida en suspensión | L & L invertida em suspensão
Inverted L & L in suspension
L & L invertita in sospensione (V SET 60 + SHAPE L)



6

Escultura diamante en suspensión
Escultura diamante em suspensão
Diamond sculpture in suspension
Scultura diamante in sospensione (SHAPE L + X)



7

Intersección 4 vías en suspensión | Interseção de 4 vias em suspensão
| 4-way intersection in suspension | Intersezione a 4 vie in sospensione (V SET 60 + SHAPE X + T)

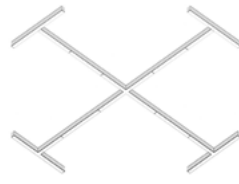

8

Diagrama de conectores | Diagrama de conectores | Connector diagram | Diagramma dei connettori

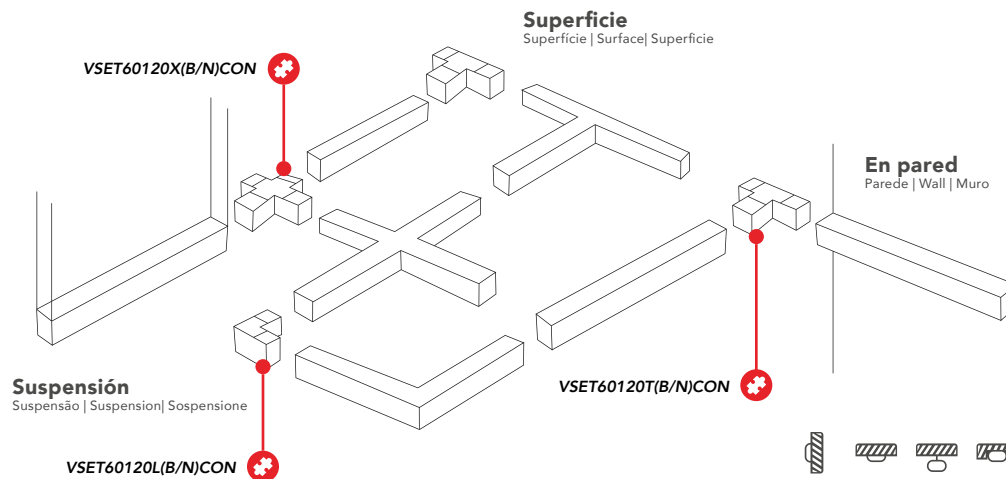

Opciones de conectividad entre luminarias y accesorios | Opções de conectividade entre luminárias e acessórios
Connectivity options between luminaires and accessories | Opzioni di connettività tra apparecchi di illuminazione e accessori



Accesorios | Acessórios | Accessories | Accessori

V SET 60 UP

Perfil De luz superior VSET60 CCT, 30% luz de luminaria de 90/120cm | Perfil de luz superior VSET60 CCT, 30% luz de luminária de 90/120cm | Top light profile VSET60 CCT, 30% light from 90/120cm luminaire | Profilo di luce superiore VSET60 CCT, 30% luce da apparecchio di 90/120cm.

PMMA
-Op

VSET60UP120
Perfil de luz superior
Profile with upward light
Perfil de luz superior
Profilo di luce superiore

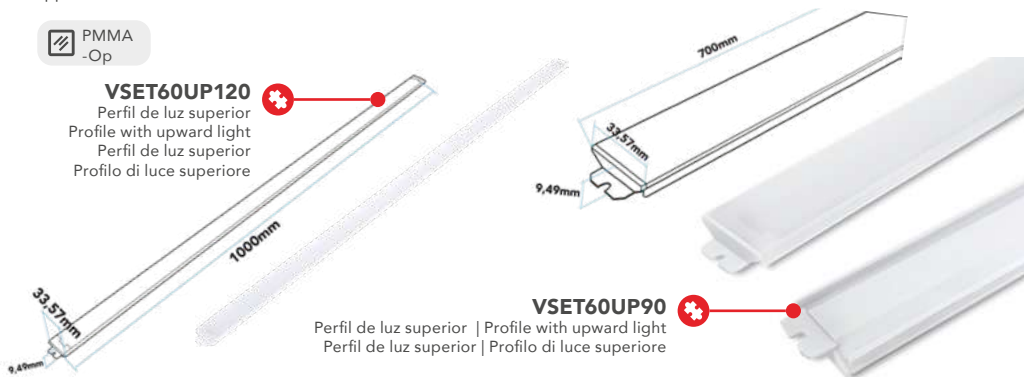

VSET60UP90
Perfil de luz superior | Profile with upward light
Perfil de luz superior | Profilo di luce superiore

V SET 60 SENSOR

Sensor PIR para luminaria V SET 60 | Sensor PIR para luminária V SET 60 | PIR sensor for V SET 60 luminaire | Sensore PIR per apparecchio V SET 60

B/N PIR

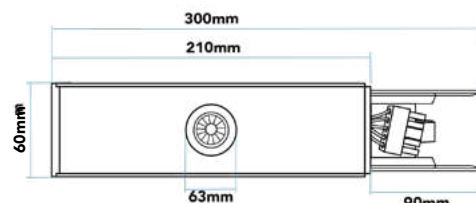

Especificaciones Sensor | Sensor Specifications

Tecnología de Sensor Tecnologia de Sensor Sensor Technology Tecnologia del Sensore	PIR Sensor
Altura max Instalación Sensor Altura máxima Max height Sensor installation Altezza massima	2.8m
Tiempo de encendido Tempo de acendimento On/Off time length Tempo di accensione	5s-8min
Ángulo de detección Ângulo de detecção Detection Angle Angolo di rilevamento	100°
Área de detección Área de detecção Detection Area Area di rilevamento	8m

Accesorios de conexión | Acessórios de conexão | Connection accessories | Accessori di connessione

V SET 60 CONECTOR

Conector 'L, T, X' Sin luz | Conector 'L, T, X' Sem luz | Connector 'L, T, X' Without light | Connettore 'L, T, X' Senza luce.

Carcasa
Al + PMMA

B/N

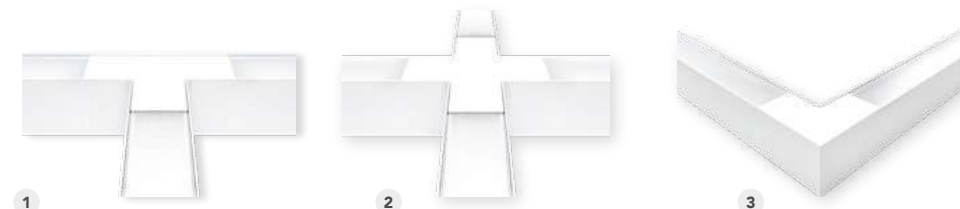

VSET60120T(B/N)CON

Conector "T" Sin luz | Conector "T" Sem luz | Connector "T" Without light
Connettore "T" Senza luce

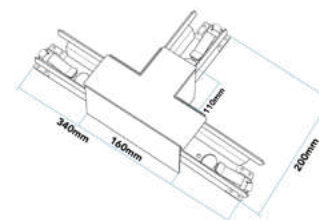

VSET60120X(B/N)CON

Conector "X" Sin luz | Conector "X" Sem luz | Connector "X" Without light
Connettore "X" Senza luce

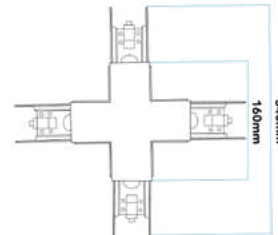

VSET60120L(B/N)CON

Conector "L" Sin luz | Conector "L" Sem luz | Connector "L" Without light
Connettore "L" Senza luce

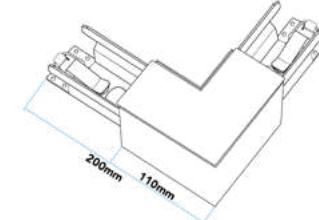

VSET60CON180

KIT conector de 180° V SET 60 | KIT conector de 180° V SET 60 | 180° Connector Kit V SET 60 | Kit connettore a 180° V SET 60.

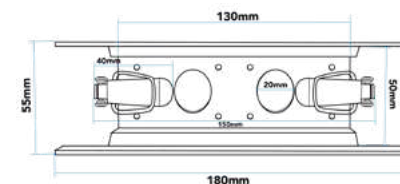

Accesorios de montaje | Acessórios de montagem | Mounting accessories | Accessori di montaggio

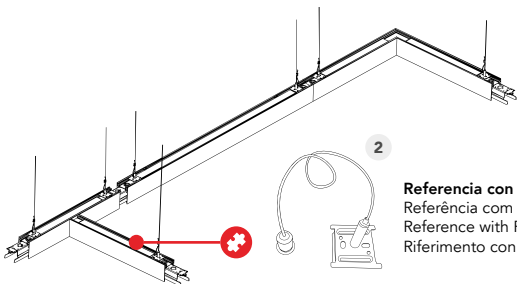

Suspensión
Suspensão | Suspension | Sospensione

Referencia con Placa VSETD60
Referência com Placa VSETD60
Reference with Plate VSETD60
Riferimento con Piastra VSETD60

Accesorios de suspensión | Acessórios de montagem | Mounting accessories | Accessori di montaggio

VSETSUSBAR 1

Kit suspensión 150cm para carril VSET con accesorio para montaje en techo Armstrong | Kit de suspensão 150cm para trilho VSET com acessório para montagem em teto Armstrong | 150cm suspension kit for VSET track with accessory for Armstrong ceiling installation | Kit di sospensione 150cm per binario VSET con accessorio per il montaggio su soffitto Armstrong

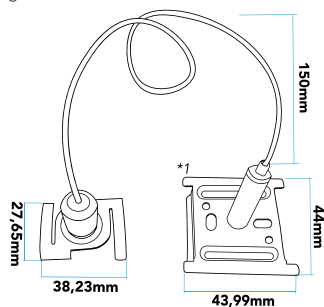

VSETSUS 2

Kit suspension VSET (2 unid.)
Kit de suspensão VSET (2 unid.)
VSET suspension kit (2 units)
Kit di sospensione VSET (2 unid.)

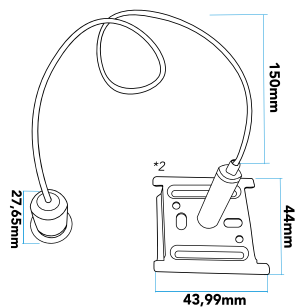

Accesorios de empotrar | Acessórios de embutir | Recess accessories | Accessori di incassare

VSET60CLIP

Kit conector para empotrar V SET 60 en techo | Kit conector para embutir V SET 60 no teto | Connector kit for recessed V SET 60 in the ceiling | Kit connettore per incasso V SET 60 nel soffitto.

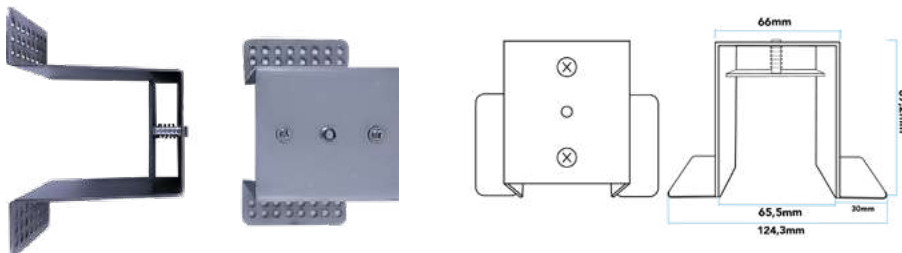

Accesorios de superficie | Acessórios de embutir | Recess accessories | Accessori di incassare

BRACKETVSET60(B/N)

Kit conector, Soporte de pared para V SET 60 (2 unidades/set) | Kit conector, Suporte de parede para V SET 60 (2 unidades/conjunto) | Connector kit, Wall mount for V SET 60 (2 units/set) | Kit connettore, Supporto a parete per V SET 60 (2 unità/set)

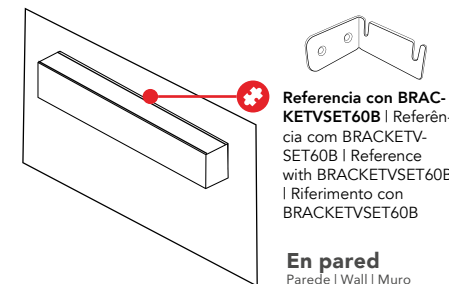
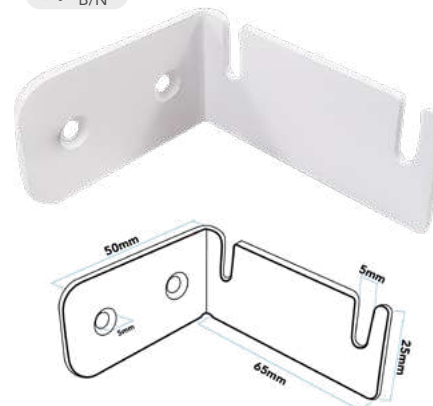

Referencia con BRACKETVSET60B | Referência com BRACKETVSET60B | Reference with BRACKETVSET60B | Riferimento con BRACKETVSET60B

En pared
Pared | Wall | Muro

* Obligatorio para el uso de V SET 60 en pared | Obrigatório para o uso do V SET 60 na parede | Required for the use of V SET 60 on the wall | Obbligatorio per l'uso del V SET 60 a parete.

KITSURFVSET60

Kit para montaje de superficie para V SET 60 (2 unidades/set) | Kit para montagem de superficie para V SET 60 (2 unidades/conjunto) | Surface mounting kit for V SET 60 (2 units/set) | Kit per montaggio a superficie per V SET 60 (2 unità/set).

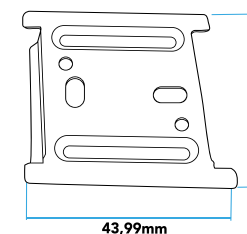

TAPA PARA V SET 60

Kit conector, Soporte de pared para V SET 60 (2 unidades/set) | Kit conector, Suporte de parede para V SET 60 (2 unidades/conjunto) | Connector kit, Wall mount for V SET 60 (2 units/set) | Kit connettore, Supporto a parete per V SET 60 (2 unità/set)





SET

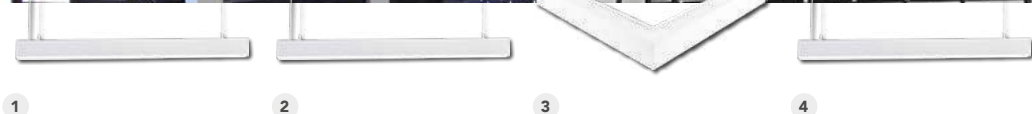

SET S

IP20 CRI90

REF	Op/Estr	W	Lm	Color	Beam	Angle	Dim
SETSCBO	Op	15	1500	3000K	BL	120°	0-10V
SETSCBP	Estr	15	1290	3000K	BL	120°	0-10V
SETSCBO95	Op	15	1500	3000K	BL	95°	0-10V
SETSCNO	Op	15	1500	3000K	NG	120°	0-10V
SETSCNP	Estr	15	1290	3000K	NG	120°	0-10V
SETSCNO95	Op	15	1500	3000K	NG	95°	0-10V
SETSFBO	Op	15	1500	4000K	BL	120°	0-10V
SETSFBP	Estr	15	1290	4000K	BL	120°	0-10V
SETSFBO95	Op	15	1500	4000K	BL	95°	0-10V
SETSFNO	Op	15	1500	4000K	NG	120°	0-10V
SETSFNP	Estr	15	1290	4000K	NG	120°	0-10V
SETSFNO95	Op	15	1500	4000K	NG	95°	0-10V

SET M

IP20 CRI90

REF	Op/Estr	W	Lm	Color	Beam	Angle	Dim
SETMCBO	Op	22	2200	3000K	BL	120°	0-10V
SETMCBP	Estr	22	1892	3000K	BL	120°	0-10V
SETMCBO95	Op	22	2200	3000K	BL	95°	0-10V
SETMCNO	Op	22	2200	3000K	NG	120°	0-10V
SETMCNP	Estr	22	1892	3000K	NG	120°	0-10V
SETMCNO95	Op	22	2200	3000K	NG	95°	0-10V
SETMFBO	Op	22	2200	4000K	BL	120°	0-10V
SETMFBP	Estr	22	1892	4000K	BL	120°	0-10V
SETMFBO95	Op	22	2200	4000K	BL	95°	0-10V
SETMFNO	Op	22	2200	4000K	NG	120°	0-10V
SETMFNP	Estr	22	1892	4000K	NG	120°	0-10V
SETMFNO95	Op	22	2200	4000K	NG	95°	0-10V

SET L

IP20 CRI90

REF	Op/Estr	W	Lm	Color	Beam	Angle	Dim
SETLCBO	Op	30	3000	3000K	BL	120°	0-10V
SETLCBP	Estr	30	2580	3000K	BL	120°	0-10V
SETLCBO95	Op	30	3000	3000K	BL	95°	0-10V
SETLCNO	Op	30	3000	3000K	NG	120°	0-10V
SETLCNP	Estr	30	2580	3000K	NG	120°	0-10V
SETLCNO95	Op	30	3000	3000K	NG	95°	0-10V
SETLFBO	Op	30	3000	4000K	BL	120°	0-10V
SETLFBP	Estr	30	2580	4000K	BL	120°	0-10V
SETLFBO95	Op	30	3000	4000K	BL	95°	0-10V
SETLFNO	Op	30	3000	4000K	NG	120°	0-10V
SETLFNP	Estr	30	2580	4000K	NG	120°	0-10V
SETLFNO95	Op	30	3000	4000K	NG	95°	0-10V

REF	Op/Estr	W	Lm	Color	Body	Beam	Voltage
SETACBO	Op	30	3000	3000K	BL	120°	0-10V
SETACBP	Estr	30	2580	3000K	BL	120°	0-10V
SETACBO95	Op	30	3000	3000K	BL	95°	0-10V
SETACNO	Op	30	3000	3000K	NG	120°	0-10V
SETACNP	Estr	30	2580	3000K	NG	120°	0-10V
SETACNO95	Op	30	3000	3000K	NG	95°	0-10V
SETAFBO	Op	30	3000	4000K	BL	120°	0-10V
SETAFBP	Estr	30	2580	4000K	BL	120°	0-10V
SETAFBO95	Op	30	3000	4000K	BL	95°	0-10V
SETAFNO	Op	30	3000	4000K	NG	120°	0-10V
SETAFNP	Estr	30	2580	4000K	NG	120°	0-10V
SETAFNO95	Op	30	3000	4000K	NG	95°	0-10V

Dimensiones | Dimensões | Dimensions | Dimensioni

REF	H	L	W	Q
1	82 mm	1135 mm	62 mm	2
2	82 mm	575 mm	62 mm	2
3	82 mm	580 x 580 mm	62 mm	2
4	82 mm	855 mm	62 mm	2

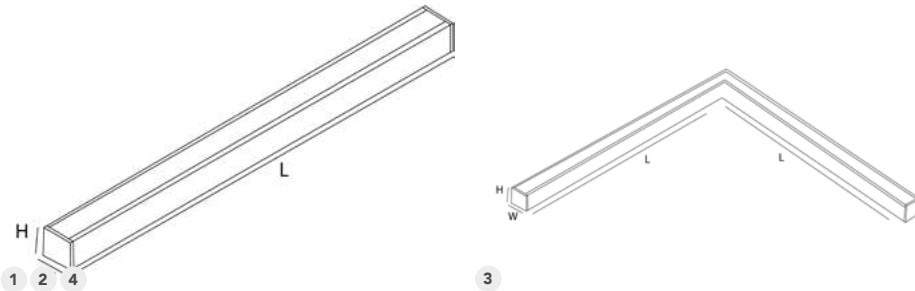
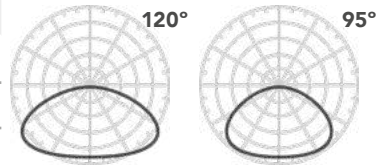
Beneficios | Benefits | Benefici

- Efecto de luz totalmente continuo | Efeito de luz totalmente contínuo | Beautiful fully continuous light effect | Effetto luce completamente continuo
- Disponible en tres longitudes con difusor ópalo o prismático 120° o 95° | Disponível em três comprimentos com difusor opalino ou prismático de 120° ou 95°. | Available in three lengths with opal or prismatic diffuser 120° or 95° | Disponibile in tre lunghezze con diffusore opalino o prismatico da 120° o 95°.
- Cuerpo fabricado de aleación de aluminio de alta calidad disponible en blanco o negro | Corpo em liga de alumínio de alta qualidade disponível em branco ou preto | High-quality aluminium alloy luminaire body available in black or white | Corpo in lega di alluminio di alta qualità disponibile in bianco o nero
- Conectores robustos en los puntos de conexión y ajustadores térmicos de última generación para evitar fugas de luz en las juntas o extremos. | Conectores robustos nos pontos de ligação e reguladores térmicos de última geração para evitar fugas de luz nas juntas ou extremidades. | Robust bracketry at connection points and cutting edge thermal adjusters to prevent light spill at joints or ends. | Connettori robusti nei punti di connessione e regolatori termici all'avanguardia per evitare perdite di luce in corrispondenza di giunti o estremità.



Instalación de superficie en techo | Instalação de superfície no teto | Surface installation on ceiling | Installazione a superficie su soffitto

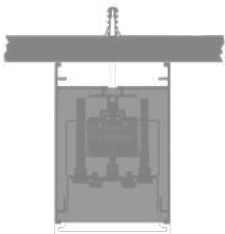

Instalación empotrado en techo | Instalação embutida no teto | Recessed installation on ceiling | Installazione a incasso su soffitto

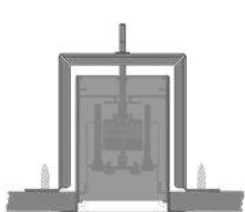

Instalación en suspensión en techo | Instalação suspensa no teto | Suspension installation on ceiling | Installazione a sospensione su soffitto

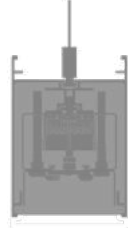

SET KIT MONT

SETKITSUS



Kit suspensión para Luminaria SET max 1,5m | Kit de suspensão para luminária SET max 1,5m | Suspension KIT for SET Luminaire max 1,5m | Kit sospensione per apparecchio SET max 1,5m

SETBOXSUSB



Kit de suspensión con caja eléctrica para luminaria SET en Blanco | Kit de suspensão com caixa elétrica para luminária SET em Branco | Suspension Kit w/ electrical box for SET Luminaire White | Kit di sospensione con scatola elettrica per apparecchio SET colore Bianco

SETBOXSUSN



Kit de suspensión con caja eléctrica para luminaria SET en Negro | Kit de suspensão com caixa elétrica para luminária SET em Preto | Suspension Kit w/ electrical box for SET Luminaire Black | Kit sospensione con scatola elettrica per apparecchio SET colore Nero



SETCLIP



KIT de montaje para empotrar para luminarias SET (2 unidades) | KIT de encastrar para luminárias SET (2 unidades) | Trimless Connection KIT for SET Luminaire | KIT di montaggio ad incasso per apparecchi SET (2 unità)

SETJOINER



Kit de conexión interna para Luminaria SET | Kit de ligação interna para luminária SET | Trimless Connection KIT for SET Luminaire | Kit connessione interna per apparecchio SET

SETMONT



Accesorios de montaje Superficie para Luminaria SET (1 unidad) | Acessórios de montagem saliente para luminária SET (1 unidade) | Kit for surface mounting for SET Luminaire (1 unit) | Accessori per montaggio su superficie per apparecchio SET (1 unità)

SET ACCESOR

SETCAPB



Tapas finales para luminarias SET - (2 unidades) Blanco | Terminais para luminárias SET - (2 unidades) Branco | Final end CAP for SET Luminaires- (2 units) White | Tappi terminali per apparecchi SET - (2 unità) Bianco

BL

SETCAPN



Tapas finales para luminarias SET - (2 unidades) Negro | Terminais para luminárias SET - (2 unidades) Preto | Final end CAP for SET Luminaires- (2 units) Black | Tappi terminali per apparecchi SET - (2 unità) Nero

NG

SETEXPB



Accesorio expansor del difusor luminarias SET Blanco (2 unidades) | Acessório expansor do difusor da luminária SET branca (2 unidades) | Trim for Diffuser expansion for SET Luminaires (2 units) White | Accessorio espansore diffusore per apparecchi SET bianco (2 unità)

BL

SETEXPN



Accesorio expansor del difusor luminarias SET Negro (2 unidades) | Acessório expansor do difusor da luminária SET preta (2 unidades) | Trim for Diffuser expansion for SET Luminaires (2 units) Black | Accessorio espansore diffusore per apparecchi SET nero (2 unità)

NG

SETTRIM



Embellecedor tapa final luminarias SET (2 unidades) | Acabamento final da luminária SET (2 unidades) | Final Cap for SET luminaires (2 units) | SET copri testata apparecchio (2 pezzi)

GR

SET DIFUSOR

SETOPAL



Difusor Opal para luminaria SET 120° (precio por metro) | Difusor Opal para luminária SET 120° (preço por metro) | Opal Diffuser for SET Luminaire 120° (price per meter) | Diffusore opalino per apparecchio SET 120° (prezzo al metro)

SETPRISMA



Difusor Prismático para luminaria SET (precio por metro) | Difusor prismático para luminária SET (preço por metro) | Prismatic Diffuser for SET Luminaire (price per meter) | Diffusore prismatico per apparecchio SET (prezzo al metro)

SETOPAL95



Difusor Opal para luminaria SET 95° (pre cortado) | Difusor opala para luminária SET 95° (pré-cortado) | Opal Diffuser for SET Luminaire 95° (pre cut) | Diffusore opalino per apparecchio SET 95° (pretagliato)





LCR



Dimensiones | Dimensões | Dimensions | Dimensioni



1	H: 39.4 mm	L: 1200 mm	W: 69.8 mm	10
2	H: 39.4 mm	L: 1500 mm	W: 69.8 mm	10

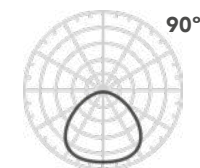

PMMA-Op

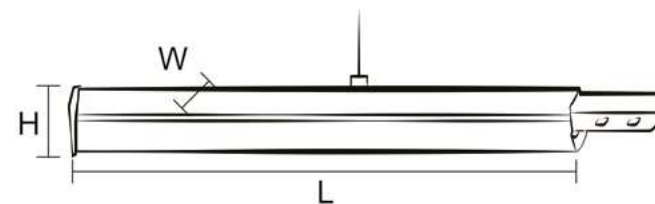

LCR



* Ver | see | vedere pg. 27

REF	W	Lm	Color	Beam	Temp	Options
1 LCR3806F	40*	6400	4000K	BL	90°	
2 LCR3813F	50*	8000	4000K	BL	90°	
1 LCR3844F	60*	9600	4000K	BL	90°	
1 LCR3820B	60*	9600	6000K	BL	90°	
2 LCR3851F	70*	12000	4000K	BL	90°	
2 LCR3837B	70*	12000	6000K	BL	90°	

* Más opciones de W disponibles, consultar con un gestor de servicios de ROBLAN | Mais opções W disponíveis, consulte um gerente de serviço ROBLAN.
 * More W options available, consult with a ROBLAN service manager | Altre opzioni W disponibili, consultare un responsabile dell'assistenza ROBLAN.



LCR RAIL

LCRAIL120WE

LCRAIL120W

LCRAIL150W



Rail para luminaria LCR 120 cm 8 cables Blanco - sin conexión en un extremo | Calha para Luminária LCR 120 cm 8 cabos Branco - sem conexão numa extremidade | Trunking Rail for LCR 120 cm 8 cores White - end without connection plate | Binario per apparecchio LCR 120 cm 8 cavi Bianco - senza connessione ad un'estremità

BL

Rail para luminaria LCR 120 cm 8 cables Blanco | Calha para Luminária LCR 120 cm 8 cabos Branco | Trunking Rail for LCR 120 cm 8 cores White | Binario per apparecchio LCR 120 cm 8 cavi Bianco

BL

Rail para luminaria LCR 150cm 8 cables Blanco | Calha para Luminária LCR 150cm 8 cabos Branco | Trunking Rail for LCR 150 cm 8 cores White | Binario per apparecchio LCR 150cm 8 cavi Bianco

BL

LCRAIL300W



Rail para luminaria LCR 300 cm 8 cables Blanco | Calha para Luminária LCR 300 cm 8 cabos Branco | Trunking Rail for LCR 300 cm 8 cores White | Binario per apparecchio LCR 300 cm 8 cavi Bianco

BL

CLIP LCR

LCRMCLIP



LCRSURF



KIT MONTAJE LCR

LCRSUSP



Clip de Montaje para LCR | Clipe de montagem para LCR | Surface Mounting Clip for LCR | Clip di montaggio per LCR

Clip de Superficie para LCR | Clipe de Superficie LCR | Surface Mounting Clip for LCR for Grid Ceilings | Clip di superficie CSF

Kit Suspension para LCR 3m de cable | Kit de suspensão para cabo LCR 3m | Suspension Kit for LCR 3m Wire | Kit di sospensione per cavo LCR 3m



BLIND CAP LCR

LCRBLIND120



LCRBLIND150



Tapa ciega para LCR de 1200mm | Tampa cega para 1200mm LCR | Blank cover for LCR 1200mm | Copertura cieca per LCR 1200mm

Tapa ciega para LCR de 1500mm | Tampa cega para 1500mm LCR | Blank cover for LCR 1500mm | Copertura cieca per LCR 1500mm

DIFFUSOR LCR

LCRLENS30



LCRLENS60



LCRLENS120



Diffusor de 30° para LCR | difusor 30° para CSF | 30° Lens for LCR | Diffusore 30° per CSF

Diffusor de 60° para LCR | difusor 60° para CSF | 60° Lens for LCR | Diffusore 60° per CSF

Diffusor de 120° para LCR | difusor 120° para CSF | 120° Lens for LCR | Diffusore 120° per CSF

CONECTOR LCR

LCRCONN8



LCRT2CONNW



LCRXCONNW



Conector 8 cable Luminaria LCR | Conector 8 cabos Luminária LCR | Feed in connector 8 cores | Connettore 8 cavo Apparecchio LCR

Conector T para LCR out-in-out Branco | Conector T para LCR out-in-out Branco | T Connector for LCR out-in-out White | Raccordo a T per LCR out-in-out Bianco

Conector X para LCR Branco | Conector X para LCR Branco | X Connector for LCR White | Connettore X per LCR Bianco

LCRL1CONNW



LCRL2CONNW



LCRT1CONNW



Conector L para LCR in-Der out-lzq Branco | Conector L para LCR entrada direita saída esquerda branco | L connector for LCR Feed-in Right Feed-out Left White | Connettore L per LCR in-Right out-Left Bianco

Conector L para LCR out-Der in-lzq Branco | Conector L para LCR out-Right in-Left Branco | L connector for LCR Feed-out Right Feed-in Left White | Connettore L per LCR out-Dx in-Sinistra Bianco

Conector T para LCR in-out-out Branco | Conector T para LCR in-out-out Branco | T Connector for LCR in-out-out White | Raccordo a T per LCR entra-esca Bianco

CAJA LCR

LCRTBOXW



LCRFBOXW



TAPA LCR

LCRCAP



Caja Final para LCR Blanca | Caixa Final para LCR Branco | LCR Terminal Box White | Scatola finale per LCR bianco

Caja Alimentación para LCR Blanca | Caixa de alimentação CSF branca | Feed IN Box for LCR White | Scatola di alimentazione CSF bianca

Tapa Final para LCR Blanca | Tampa final para CSF branco | End Cap for LCR White | Tappo terminale per CSF bianco



V SET



1

2

V SET

- IP20
- IK08
- CRI80
- DALI

* Ver | see | vedere pg. 27

	REF	W	Lm					
2	Ref VSETUGR90B	23	2420	3000 4000 5700	BL	90°	0-10V	D6 D16
2	Ref VSETUGR90N	23	2420	3000 4000 5700	NG	90°	0-10V	
2	Ref VSETR90B	23	2990	3000 4000 5700	BL	80°	0-10V	
2	Op VSETD90B	23	2650	3000 4000 5700	BL	90°	0-10V	
2	Ref VSETR90N	23	2990	3000 4000 5700	NG	80°	0-10V	
2	Op VSETD90N	23	2650	3000 4000 5700	NG	90°	0-10V	
1	Ref VSETUGR120B	27	2800	3000 4000 5700	BL	90°	0-10V	
1	Ref VSETUGR120N	27	2800	3000 4000 5700	NG	90°	0-10V	
1	Op VSETD120B	27	3100	3000 4000 5700	BL	90°	0-10V	
1	Op VSETD120N	27	3100	3000 4000 5700	NG	90°	0-10V	
1	Ref VSETR120B	30	3900	3000 4000 5700	BL	80°	0-10V	
1	Ref VSETR120N	30	3900	3000 4000 5700	NG	80°	0-10V	

- V AC200-240
- P.F.>0.95
- 20°C ~ +40°C
- L70B50 60000h

Dimensiones | Dimensões | Dimensions | Dimensioni

	H: 72 mm	L: 850 mm	W: 50 mm	8
1				
2		L: 1130 mm	W: 50 mm	8

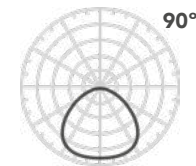

- Al + PMMA
- Ref

1130*50*72m

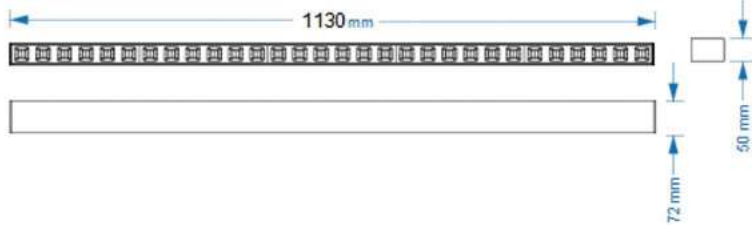

1

850*50*72m

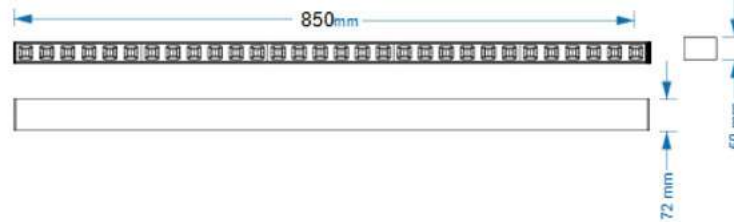

2

V SET ACCESOR

VSETCON180



KIT conector de 180° VSET | KIT conector VSET 180°
| Connector kit for 180° VSET | KIT connettore VSET 180°

VSETOPAL



Difusor OPAL para luminaria VSET (precio por metro)
| | Difusser OPAL for VSET (p/meter) |

VSETTRIM / VSETTRIMN



Embellecedor conexión VSET (1 unidad) Blanco / Negro | Trim Connector VSET (1 unit) White / Black | Embellecedor de Conexão VSET (1 unidade) Branco / Preto | Rifinitura Connessione VSET (1 unità) Bianco / Nero

BL NG

VSETCABLE



Cable transparente de 150cm 5x0.75mm para VSET |
| Transparent Cable 150cm 5x0.75mm for VSET | Cavo trasparente 150cm 5x0.75mm per VSET

V SET KIT MONT

VSETSUSTBAR



Kit suspensión 150cm para carril VSET con accesorio para montaje en techo armstrong | Kit de suspensão 150cm para trilho VSET com acessório para montagem no teto Armstrong | Suspension mounting Kit 150cm for VSET with accessory for armstrong ceiling | Kit sospensione 150cm per binario VSET con accessorio per montaggio a soffitto Armstrong

VSETSUS



Kit suspensión VSET - VSET60 con cable, tensores y anclajes de techo (2 unds) | | Suspension mouting Kit VSET | Kit di sospensione VSET

V SET UP

VSETUP



Perfil De luz superior CCT 420mm 30% luz de luminaria de 90cm | Perfil de Luz Superior CCT 420mm 30% luz da luminária de 90cm | Profile with upward light CCT 420mm 30% for Luminaire 90cm luminaire | Profilo luminoso superiore CCT 420mm 30% di luce dell'apparecchio da 90cm

VSETUP120



Perfil De luz superior CCT 420mm 30% luz de luminaria de 120cm | Perfil de Luz Superior CCT 420mm 30% luz da luminária de 120cm | Profile with upward light CCT 420mm 30% for Luminaire 120cm luminaire | Profilo luminoso superiore CCT 420mm 30% di luce dell'apparecchio da 120cm

VSETUPREF



REFLECTOR 25% luz superior para 90cm | REFLETOR 25% luz superior para 90cm | Reflector 25% Upper Light for 90cm | RIFLETTORE Luce superiore del 25% per 90 cm

VSETUPREF120



REFLECTOR 25% luz superior para 120cm | REFLETOR 25% luz superior para 120cm | Reflector 25% Upper Light for 120cm | RIFLETTORE Luce superiore del 25% per 120 cm





RV SET



RV SET

IP20 CRI80

* Ver | see | vedere pg. 27

QTY	REF	FINISH	W	Lm	TEMPERATURE	COLOR	ANGLE	CONTROL	INSTALLATION	REMARKS
2	RVSETD90B	Op	23	2530	3000 4000 5700	BL	110°	0-10V		
2	RVSETD90N	Op	23	2300	3000 4000 5700	NG	110°	0-10V		
2	RVSETR90B	Ref	23	2990	3000 4000 5700	BL	90°	0-10V		
2	RVSETR90N	Ref	23	2530	3000 4000 5700	NG	90°	0-10V		
1	RVSETD120B	Op	30	3300	3000 4000 5700	BL	110°	0-10V		
1	RVSETD120N	Op	30	3000	3000 4000 5700	NG	110°	0-10V		
1	RVSETR120B	Ref	30	3900	3000 4000 5700	BL	90°	0-10V		
1	RVSETR120N	Ref	30	3300	3000 4000 5700	NG	90°	0-10V		

D3
D4
D5
D6
E2
E5
E13
E20
E22

V AC220-240V -20°C ~ +40°C L70B50 60000h CCT



Dimensiones | Dimensões | Dimensions | Dimensioni

QTY	H	L	W	WT	PK
1	33 mm	1144 mm	62.5 mm	1.1 kg	6
2	33 mm	864 mm	62.5 mm	0.9 kg	6

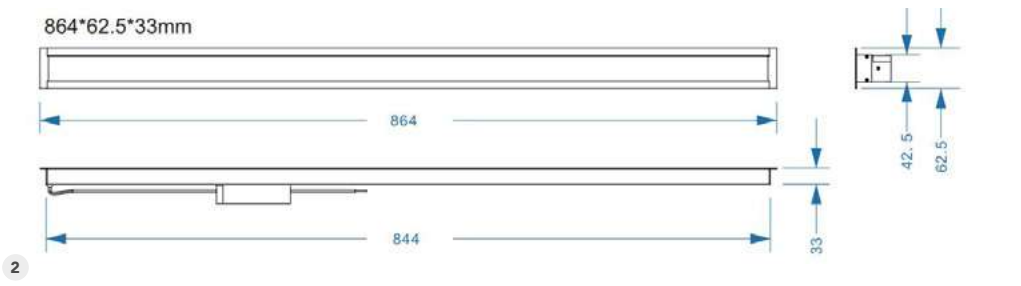
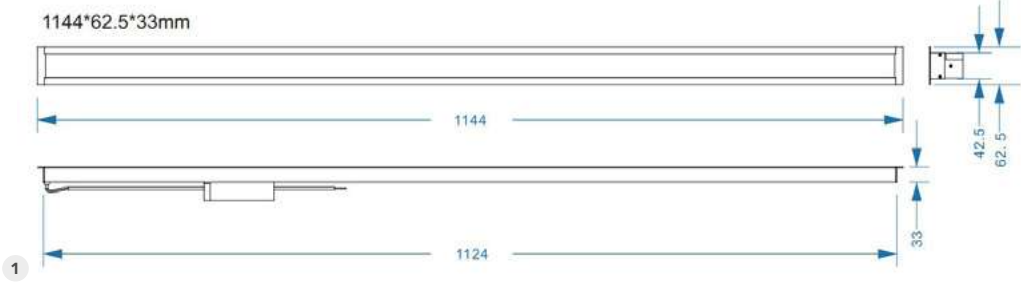
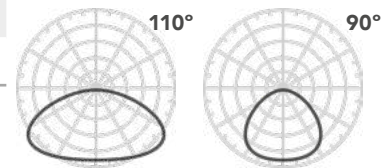

RV SET ACCESOR

RVSETGRILLB120



Rejilla Accesorio Blanca para RVSET120 OPAL (4piezas 1 set) | White Accessory Grid for RVSET120 OPAL (4 pieces 1 set) |

RVSETGRILLN120



Rejilla Accesorio Negra para RVSET120 OPAL (4piezas 1 set) | Black Accessory Grid for RVSET120 OPAL (4 pieces 1 set) |

DIFPRISM RVSET1144



Difusor Prismatico RVSET 1144mm | Prismatic Diffuser RVSET 1144mm |

DIFPRISM RVSET860



Difusor Prismatico RVSET 860mm | Prismatic Diffuser RVSET 860mm |

RVSETGRILLN



Rejilla Accesorio Negra para RVSET OPAL | White Accessory Grid for RVSET Opal |

RVSETGRILLB



Rejilla Accesorio Blanca para RVSET OPAL | Black Accessory Grid for RVSET Opal |

RVSETCON



Kit Conector RVSET (2 piezas - 1 set) | RVSET Connector Kit (2 pieces - 1 set) |

