

DOSIER ILUMINACIÓN EN RESTAURACIÓN



Escanea para ver nuestro
Dosier de Iluminación
en restauración



Dosier Iluminación en restauración: La luz en la restauración.

La iluminación es fundamental en la hostelería, ya que influye directamente en la experiencia del cliente. Una mala iluminación puede generar rechazo, mientras que una adecuada crea un ambiente cómodo para conversar, comer o trabajar. Además de la distribución, acústica y climatización, la iluminación es clave para el éxito de bares y restaurantes.

Dossiê Iluminação em restauração: A luz na restauração.

A iluminação é fundamental na indústria da hospitalidade, pois influencia diretamente a experiência do cliente. Uma má iluminação pode causar rejeição, enquanto uma boa iluminação cria um ambiente confortável para conversar, comer ou trabalhar. Além da distribuição, acústica e climatização, a iluminação é essencial para o sucesso de bares e restaurantes.

Lighting in Hospitality Brochure: Lighting in the restaurant industry.

Lighting is essential in the hospitality industry as it directly impacts the customer experience. Poor lighting can cause discomfort, while good lighting creates a comfortable space for talking, eating, or working. Along with table arrangement, acoustics, and climate control, lighting is key to the success of bars and restaurants.

Dossier Illuminazione nella ristorazione: La luce nella ristorazione.

L'illuminazione è fondamentale nell'industria dell'ospitalità, poiché influisce direttamente sull'esperienza del cliente. Una cattiva illuminazione può generare disagio, mentre una buona illuminazione crea un ambiente confortevole per parlare, mangiare o lavorare. Oltre alla disposizione dei tavoli, all'acustica e alla climatizzazione, l'illuminazione è cruciale per il successo di bar e ristoranti.

ILUMINACIÓN TIRAS LED

Fitas LED | LED strips | Strisce LED



MODEL	GAMA	W/m	Lm m		Leds/m						
Tira Z A	LED T	4,8 9,6 14,4 24	103 108 1144 1171 1224 1290 1320 1330 1380 1500 2219 2271 2374 2580 288 499 511 534 54 580		60 120 140	CRI80	24V AC	IP20	100 50	50000h	PG 508
Tira Z A REEL	LED T	4,8 9,6 14,4 14,5 24	1171 1224 1290 1320 1380 1500 2219 2271 2374 2580 511 534 600		60 120 140	CRI80	24V AC	IP20	100 50	50000h	PG 510
Tira Z RGB A	LED T	8,4 14,5	360 600		36 60	CRI	24V AC	IP20	100	50000h	PG 511
Tira Z C	LED T	4,8 9,6 14,4	1076 1101 1150 1213 1241 1298 1330 1410 253 469 47 480 502 546 95 97		60 140	CRI80	24V AC	IP67	100 50	50000h	PG 512
Tira Z C REEL	LED T	4,8 9,6 14,4	1030 1100 1150 1241 1298 1410 480		60 140	CRI80	24V AC	IP67	100 50	50000h	PG 514
Tira Z RGB C	LED T	8,4 14,5	339 564		36 60	CRI	24V AC	IP67	100	50000h	PG 515
Tira Z RGBW	LED T	19,2	560 589		60	CRI	24V AC	IP20 65	100	50000h	PG 516
Tira Z ECO	LED T	4,5 14,5	1056 1104 1200 317 332 360		36 120	CRI80	24V AC	IP20	166.7 50	35000h	PG 517
DOTFREE COB STRIP	LED T	5 11 15 18	1000 1230 1245 1350 396 475 880		384 504 1008	CRI90	24V AC	IP20	41.65 41.67 41.7	50000h	PG 518
STRIP IP20	LED T	4,8 9,6 14,4 19,2	1036 1164 1200 1224 216 270 288 60 690 96 982		60 120 240	CRI70	12V AC	IP20	25 50	50000-100000h	PG 519
STRIP IP67	LED T	4,8 7,2 9,6 14,4 19,2	1036 110 1164 1200 1224 198 222 252 264 504 522 534 60 90 982		30 60 120 240	CRI70	12V AC	IP54 67	100 25 50	50000-100000h	PG 520
STRIP NANO	LED T	14,4 19,2	1036 798 982		60 120	CRI70	24V AC	IP67	50	50000-100000h	PG 521



TIRA Z A



1

Tira Z A IP20 CRI80

REF	LED CHIP	W/M	Lm/M	LED S/M	✂-mm	⚡
1 ZTAR6272	SMD 3528	4,8	103	60	100	24V
1 ZTAY6296	SMD 3528	4,8	108	60	100	24V
1 ZTAG6319	SMD 3528	4,8	288	60	100	24V
1 ZTAB6258	SMD 3528	4,8	54	60	100	24V
1 ZTAWW6364	SMD 2835	4,8	499	60	100	24V
1 ZTAWL6357	SMD 2835	4,8	511	60	100	24V
1 ZTACL6340	SMD 2835	4,8	534	60	100	24V
1 ZTADL6333	SMD 2835	4,8	580	60	100	24V
1 ZTAWW6562	SMD 2835	9,6	1144	140	50	24V
1 ZTAWL6555	SMD 2835	9,6	1171	140	50	24V
1 ZTACL6548	SMD 2835	9,6	1224	140	50	24V
1 ZTADL6531	SMD 2835	9,6	1330	140	50	24V
1 ZTAWW6449	SMD 2835	14,4	1290	60	100	24V
1 ZTAWL6432	SMD 2835	14,4	1320	60	100	24V
1 ZTACL6425	SMD 2835	14,4	1380	60	100	24V
1 ZTADL6418	SMD 2835	14,4	1500	60	100	24V
1 ZTAWL6517	SMD 2835	24	2271	120	50	24V
1 ZTAWW6524	SMD 2835	24	2219	120	50	24V
1 ZTACL6500	SMD 2835	24	2374	120	50	24V
1 ZTADL6494	SMD 2835	24	2580	120	50	24V

120° 50000hh Según el equipo de control | De acuerdo con o equipamento de controlo According to the control equipment | Secondo l'apparecchiatura di controllo



TIRA Z A CUT



2

Tira Z A CUT IP20 CRI80

REF	LED CHIP	W/M	Lm/M	LED S/M	✂-mm	⚡
2 ZTREELACL6340-C	SMD 2835	4,8	534	60	100	24V
2 ZTREELAWL6555-C	SMD 2835	9,6	1171	140	50	24V
2 ZTREELACL6548-C	SMD 2835	9,6	1224	140	50	24V
2 ZTREELAWW6449-C	SMD 2835	14,4	1290	60	100	24V
2 ZTREELAWL7699-C	SMD 2835	14,4	1320	60	100	24V
2 ZTREELACL7682-C	SMD 2835	14,4	1380	60	100	24V
2 ZTREELADL7675-C	SMD 2835	14,4	1500	60	100	24V
2 ZTREELRGB6928-C	SMD 5050	14,5	600	60	100	24V
2 ZTREELAWW6524-C	SMD 2835	24	2219	120	50	24V
2 ZTREELAWL6517-C	SMD 2835	24	2271	120	50	24V
2 ZTREELADL6494-C	SMD 2835	24	2580	120	50	24V

120° 50000hh Según el equipo de control | De acuerdo con o equipamento de controlo According to the control equipment | Secondo l'apparecchiatura di controllo

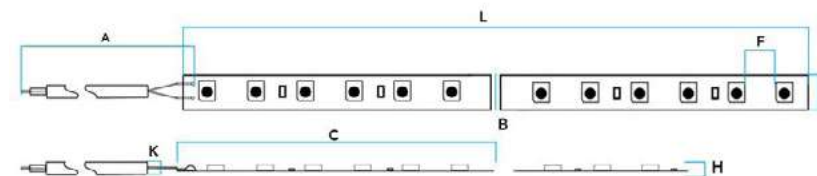

	H: 1,2 mm	L: 50000 mm	W: 8 mm	5 m
1				
2				

















TIRA Z A REEL



TIRA Z RGB A



Tira Z A REEL

REF	LED CHIP	W/M	Lm/M		LEDS/M	 -mm	
ZTREELAWL6935	SMD 2835	4,8	511	 2900-3200K	60	100	24V
ZTREELACL6340	SMD 2835	4,8	534	 3700-4250K	60	100	24V
ZTREELAWL6555	SMD 2835	9,6	1171	 2900-3200K	140	50	24V
ZTREELACL6548	SMD 2835	9,6	1224	 3700-4250K	140	50	24V
ZTREELAWW6449	SMD 2835	14,4	1290	 2600-2900K	60	100	24V
ZTREELAWL7699	SMD 2835	14,4	1320	 2900-3200K	60	100	24V
ZTREELACL7682	SMD 2835	14,4	1380	 3700-4250K	60	100	24V
ZTREELADL7675	SMD 2835	14,4	1500	 5700-6500K	60	100	24V
ZTREELRGB6928	SMD 5050	14,5	600		60	100	24V
ZTREELAWW6524	SMD 2835	24	2219	 2600-2900K	120	50	24V
ZTREELAWL6517	SMD 2835	24	2271	 2900-3200K	120	50	24V
ZTREELACL6911	SMD 2835	24	2374	 3700-4250K	120	50	24V
ZTREELADL6494	SMD 2835	24	2580	 5700-6500K	120	50	24V





 120°  50000hh  Según el equipo de control | De acordo com o equipamento de controlo
According to the control equipment | Secondo l'apparecchiatura di controllo



 Dimensiones | Dimensões | Dimensions | Dimensioni



H: 1,2 mm L: 50000 mm W: 8 mm 50 m

Tira Z RGB A

REF	LED CHIP	W/M	Lm/M		LEDS/M	 -mm	
ZTARGB6210	SMD 5050	8,4	360		36	100	24V
ZTARGB6227	SMD 5050	14,5	600		60	100	24V

 120°  50000hh  Según el equipo de control | De acordo com o equipamento de controlo
According to the control equipment | Secondo l'apparecchiatura di controllo

 Dimensiones | Dimensões | Dimensions | Dimensioni



H: 1,8 mm L: 5000 mm W: 10 mm 5/5 m

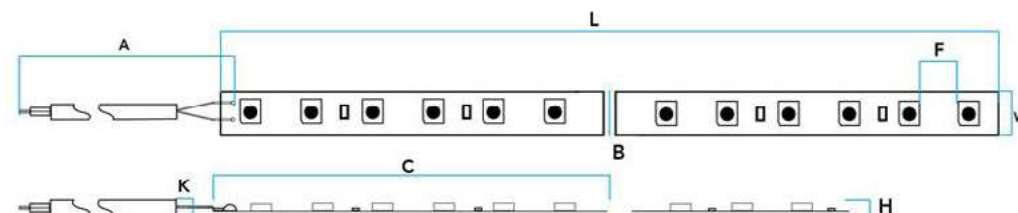



TIRA Z C



1

Tira Z C

REF	LED CHIP	W/M	Lm/M	☉	LEDS/M	✂-mm	⚡
1 ZTCR6289	SMD 3528	4,8	97	■	60	100	24V
1 ZTCY6302	SMD 3528	4,8	95	■	60	100	24V
1 ZTCG6326	SMD 3528	4,8	253	■	60	100	24V
1 ZTCB6265	SMD 3528	4,8	47	■	60	100	24V
1 ZTCWW6401	SMD 2835	4,8	469	■ 2600-2900K	60	100	24V
1 ZTCWL6395	SMD 2835	4,8	480	■ 2900-3200K	60	100	24V
1 ZTCCL6388	SMD 2835	4,8	502	■ 3700-4250K	60	100	24V
1 ZTCDL6371	SMD 3528	4,8	546	■ 5700-6500K	60	100	24V
1 ZTCWW6609	SMD 2835	9,6	1076	■ 2600-2900K	140	50	24V
1 ZTCWL6593	SMD 2835	9,6	1101	■ 2900-3200K	140	50	24V
1 ZTCCL6586	SMD 2835	9,6	1150	■ 3700-4250K	140	50	24V
1 ZTCDL6579	SMD 2835	9,6	1330	■ 5700-6500K	140	50	24V
1 ZTCWW6487	SMD 2835	14,4	1213	■ 2600-2900K	60	100	24V
1 ZTCWL6470	SMD 2835	14,4	1241	■ 2900-3200K	60	100	24V
1 ZTCCL6463	SMD 2835	14,4	1298	■ 3700-4250K	60	100	24V
1 ZTCDL6456	SMD 2835	14,4	1410	■ 5700-6500K	60	100	24V

Según el equipo de control | De acordo com o equipamento de controlo
According to the control equipment | Secondo l'apparecchiatura di controllo



TIRA Z C CUT



2

Tira Z C CUT

REF	LED CHIP	W/M	Lm/M	☉	LEDS/M	✂-mm	⚡
2 ZTREELCWL6395-C	SMD 2835	4,8	480	■ 2900-3200K	60	100	24V
2 ZTREELCCL6586-C	SMD 2835	9,6	1150	■ 3700-4250K	140	50	24V
2 ZTREELCWL6487-C	SMD 2835	14,4	1241	■ 2600-2900K	60	100	24V
2 ZTREELCWL8031-C		14,4	1030	■ 2600-2900K			24V
2 ZTREELCWL6470-C	SMD 2835	14,4	1241	■ 2900-3200K	60	100	24V
2 ZTREELCWL8048-C		14,4	1100	■ 2600-2900K			24V
2 ZTREELCCL6463-C	SMD 2835	14,4	1298	■ 3700-4250K	60	100	24V
2 ZTREELCDL6456-C	SMD 2835	14,4	1410	■ 5700-6500K	60	100	24V

Según el equipo de control | De acordo com o equipamento de controlo
According to the control equipment | Secondo l'apparecchiatura di controllo

Dimensiones | Dimensões | Dimensions | Dimensioni

1		L: 50000 mm	5 m
2	H: 7,5 mm	L: 5000 mm	W: 12 mm 5 m

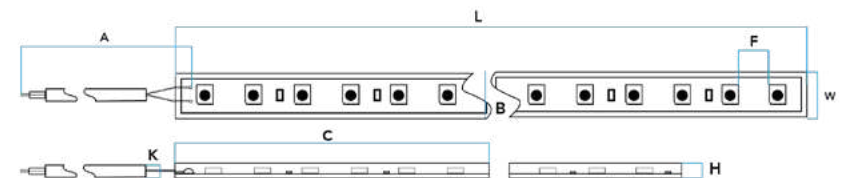



TIRA Z C REEL



Tira Z C REEL

REF	LED CHIP	W/M	Lm/M		LEDS/M	-mm	
ZTREELCWL6395	SMD 2835	4,8	480	2900-3200K	60	100	24V
ZTREELCCL6586	SMD 2835	9,6	1150	3700-4250K	140	50	24V
ZTREELCWL8031	SMD 2835	14,4	1030	2600-2900K	60	100	24V
ZTREELCWL8048	smd 2835	14,4	1100	2600-2900K	60		24V
ZTREELCWL6487	SMD 2835	14,4	1241	2600-2900K	60	100	24V
ZTREELCWL6470	SMD 2835	14,4	1241	2900-3200K	60	100	24V
ZTREELCCL6463	SMD 2835	14,4	1298	3700-4250K	60	100	24V
ZTREELCDL6456	SMD 2835	14,4	1410	5700-6500K	60	100	24V

120° 50000hh Según el equipo de control | De acordo com o equipamento de controlo
According to the control equipment | Secondo l'apparecchiatura di controllo

Dimensiones | Dimensões | Dimensions | Dimensioni



H: 1,2 mm L: 50000 mm W: 12 mm 50 m



TIRA Z RGB C



Tira Z RGB C

REF	LED CHIP	W/M	Lm/M		LEDS/M	-mm	
ZTCR6197	SMD 5050	8,4	339		36	100	24V
ZTCR6203	SMD 5050	14,5	564		60	100	24V

120° 50000hh Según el equipo de control | De acordo com o equipamento de controlo
According to the control equipment | Secondo l'apparecchiatura di controllo

Dimensiones | Dimensões | Dimensions | Dimensioni



H: 7,5 mm L: 5000 mm W: 12 mm 5 m

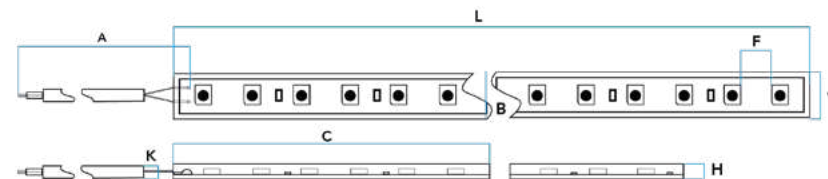



TIRA Z RGBW



Tira Z RGBW IP27

REF	LED CHIP	W/M	Lm/M	☉	LEDS/M	✂-mm	⚡
ZTARGBW6241	SMD 5050	19,2	589	☀ 2900-3200K	60	100	24V
ZTCRGBW6234	SMD 5050	19,2	560	☀ 2900-3200K	60	100	24V

120°
 50000hh
 Según el equipo de control | De acordo com o equipamento de controlo
 According to the control equipment | Secondo l'apparecchiatura di controllo

✂ Dimensiones | Dimensões | Dimensions | Dimensioni

H: 1,8 mm L: 5000 mm W: 12 mm 5/5 m

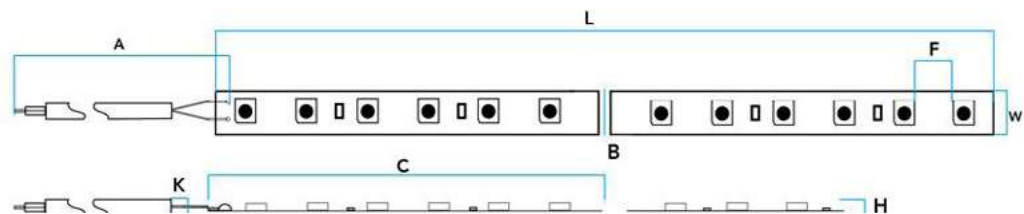

TIRA Z ECO



Tira Z ECO IP20 CRI80

REF	LED CHIP	W/M	Lm/M	☉	LEDS/M	✂-mm	⚡
ZEAWL6159	SMD 2835	4,5	317	☀ 2900-3200K	36	166.7	24V
ZEACL6142	SMD 2835	4,5	332	☀ 3700-4250K	36	166.7	24V
ZEADL6135	SMD 2835	4,5	360	☀ 5700-6500K	36	166.7	24V
ZEAWL6180	SMD 2835	14,5	1056	☀ 2900-3200K	120	50	24V
ZEACL6173	SMD 2835	14,5	1104	☀ 3700-4250K	120	50	24V
ZEADL6166	SMD 2835	14,5	1200	☀ 5700-6500K	120	50	24V

120°
 35000hh
 Según el equipo de control | De acordo com o equipamento de controlo
 According to the control equipment | Secondo l'apparecchiatura di controllo

✂ Dimensiones | Dimensões | Dimensions | Dimensioni

H: 1,2 mm L: 5000 mm W: 8 mm 5/5 m

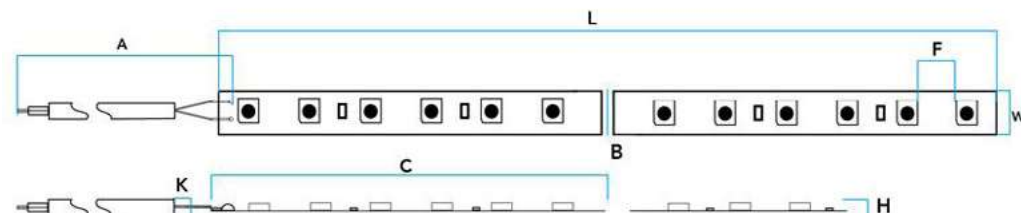



DOTFREE COB STRIP



DOTFREE COB STRIP

REF	LED CHIP	W/M	Lm/M		LED S/M		
ZCWLS9807	COB	5	396	3000K	504	41.7	24V
ZCCLS9791	COB	5	475	4000K	504	41.7	24V
ZCDLS9784	COB	5	475	6000K	504	41.7	24V
ZCWLM9838	COB	11	880	3000K	384	41.67	24V
ZCCLM9821	COB	11	1000	4000K	384	41.67	24V
ZCDLM9814	COB	11	1000	6000K	384	41.67	24V
ZCWLL9869	COB	15	1245	3000K	504	41.7	24V
ZCCLL9852	COB	15	1350	4000K	504	41.7	24V
ZCDLL9845	COB	15	1350	6000K	504	41.7	24V
ZCCCT9777	COB	18	1230	2590K / 7000K	1008	41.65	24V

145° 50000hh Según el equipo de control | De acordo com o equipamento de controlo
According to the control equipment | Secondo l'apparecchiatura di controllo

Dimensiones | Dimensões | Dimensions | Dimensioni

H: 2,0 mm L: 5000 mm W: 8 mm 5/60

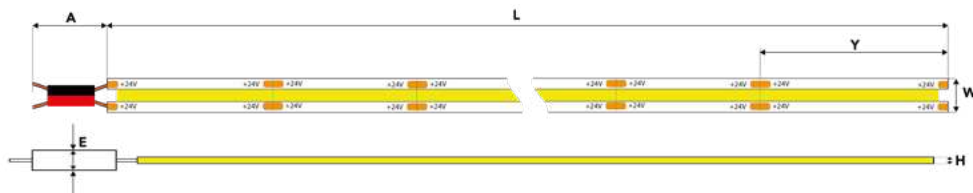

STRIP IP20



STRIP IP20

REF	LED CHIP	W/M	Lm/M		LED S/M		
LEDT48IP20A	SMD 3528	4,8	60		60	50	12V
LEDT48IP20AM	SMD 3528	4,8	96		60	50	12V
LEDT48IP20V	SMD 3528	4,8	216		60	50	12V
LEDT48IP20W	SMD 3528	4,8	288		60	50	12V
LEDT48IP20WW	SMD 3528	4,8	270		60	50	12V
LEDT48IP20R	SMD 3528	4,8	96		60	50	12V
LEDT96IP20CCT	SMD 3528	9,6	690		120	25	12V
LEDT144HIP20W	SMD 2835	14,4	1224		60	50	12V
LEDT144HIP20NW	SMD 2835	14,4	1200		60	50	12V
LEDT144HIP20WW	SMD 2835	14,4	1164		60	50	12V
LEDT192HIP20WW	SMD 3528	19,2	982		240	25	24V
LEDT192HIP20W	SMD 3528	19,2	1036		240	25	24V

120° 50000-100000hh Según el equipo de control | De acordo com o equipamento de controlo
According to the control equipment | Secondo l'apparecchiatura di controllo

Dimensiones | Dimensões | Dimensions | Dimensioni

H: 2,1 mm L: 5000 mm W: 8 mm 5/5 mm

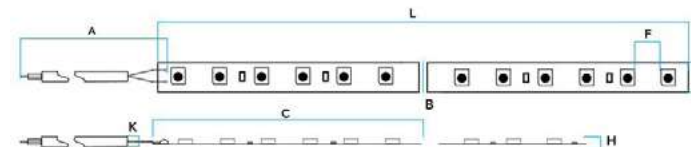



STRIP IP67



STRIP IP67

REF	LED CHIP	W/M	Lm/M		LEDS/M	-mm	
LEDT48IP67R	SMD 3528	4,8	90		60	50	12V
LEDT48IP67AM	SMD 3528	4,8	90		60	50	12V
LEDT48IP67V	SMD 3528	4,8	198		60	50	12V
LEDT48IP67A	SMD 3528	4,8	60		60	50	12V
LEDT48IP67WW	SMD 3528	4,8	252	2700-3000K	60	50	12V
LEDT48IP67FW	SMD 3528	4,8	252	3800-4400K	60	50	12V
LEDT48IP67W	SMD 3528	4,8	264	5500-6500K	60	50	12V
LEDT72IP67RGB	SMD 5050	7,2	110		30	100	12V
LEDT96IP67WW	SMD 3528	9,6	504	3000K	120	25	12V
LEDT96IP67NW	SMD 3528	9,6	522	4000K	120	25	12V
LEDT96IP67W	SMD 3528	9,6	534	6500K	120	25	12V
LEDT144HIP67WW	SMD 2835	14,4	1164	2700-3000K	60	50	12V
LEDT144HIP67NW	SMD 2835	14,4	1200	3800-4400K	60	50	12V
LEDT144HIP67W	SMD 2835	14,4	1224	5500-6500K	60	50	12V
LEDT144HIP67RGB	SMD 5050	14,4	222		60	100	24V

120° 50000-100000hh Según el equipo de control | De acordo com o equipamento de controlo
According to the control equipment | Secondo l'apparecchiatura di controllo

Dimensiones | Dimensões | Dimensions | Dimensioni



H: 7,5 mm L: 5000 mm W: 10 mm 5/5 m



STRIP NANO



STRIP NANO

REF	LED CHIP	W/M	Lm/M		LEDS/M	-mm	
LEDT192NPIP67WW	SMD 3528	19,2	982	2700K	120	50	24V
LEDT192NPIP67W	SMD 3528	19,2	1036	6500K	120	50	24V

120° 50000-100000hh Según el equipo de control | De acordo com o equipamento de controlo
According to the control equipment | Secondo l'apparecchiatura di controllo

Dimensiones | Dimensões | Dimensions | Dimensioni



H: 2,3 mm L: 5000 mm W: 10 mm 5/5 m

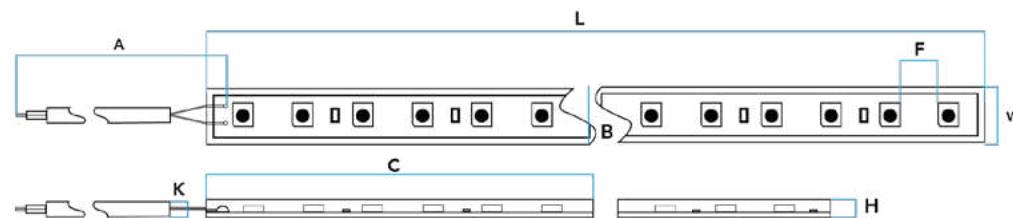

¡GRACIAS
POR ELEGIRNOS!

OBRIGADO POR NOS ESCOLHER
THANK YOU FOR CHOOSING US
GRAZIE PER AVERCI SCELTO

RESULTADOS

ENCUESTA DE SATISFACCION

2024

RESULTADOS DA PESQUISA DE SATISFAÇÃO 2024
2024 SATISFACTION SURVEY RESULTS
RISULTATI DEL SONDAGGIO DI SODDISFAZIONE 2024

**95% RECOMENDARÍAN
ROBLAN**

95% RECOMENDARIAM A ROBLAN
95% WOULD RECOMMEND ROBLAN
IL 95% RACCOMANDEREBBE ROBLAN



BLOG



Escanea para ver nuestro
BLOG



**VOLVERÍAN A CONFIAR EN NOSOTROS
EL 99% DE NUESTROS CLIENTES**

ILUMINACION
PERFILES

Perfis | Profiles | Profili

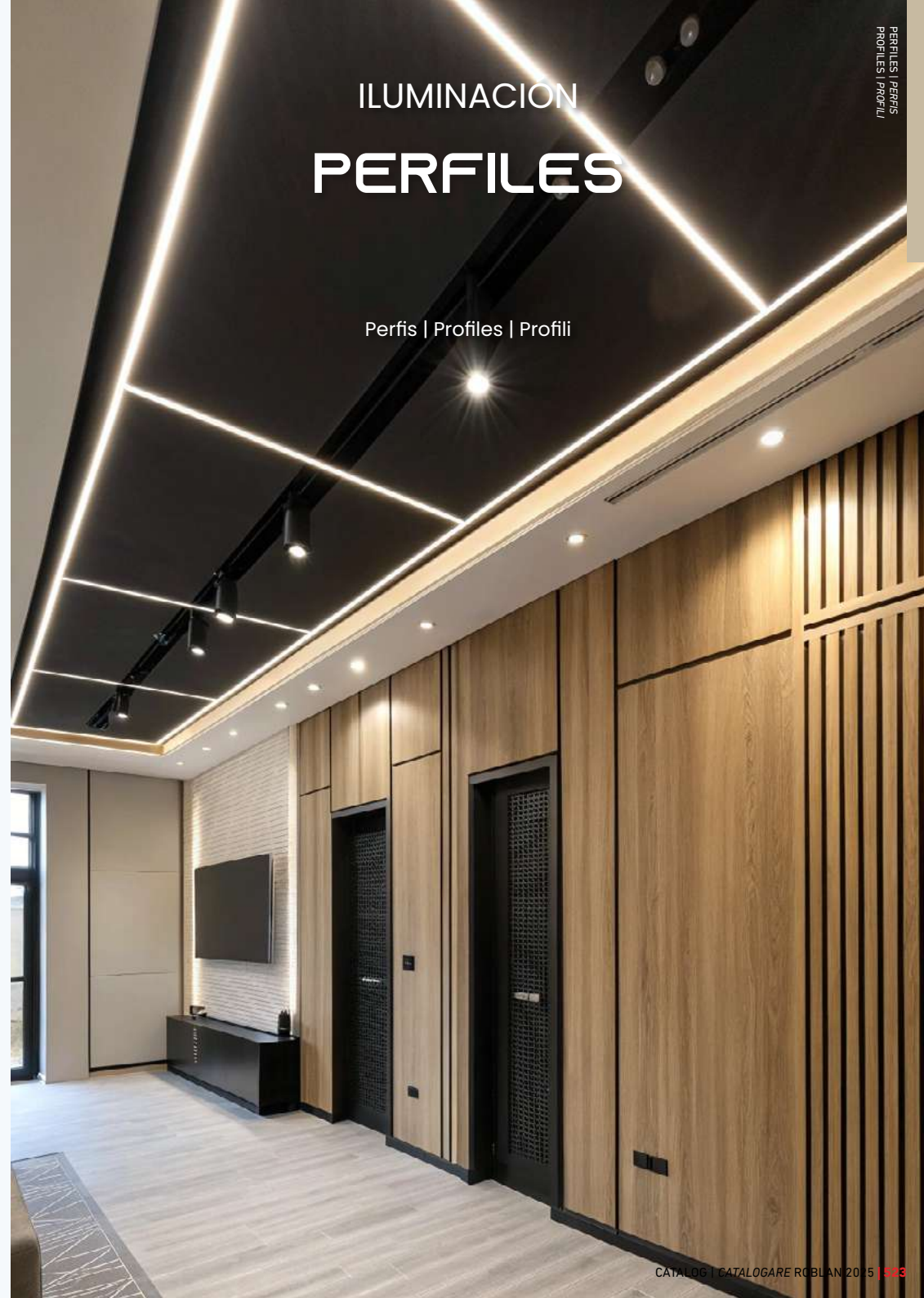

PERFIL SUPERFICIE | PERFIL DE SUPERFÍCIE | SURFACE PROFILE | PROFILO SUPERFICIALE

LEDAP1417100

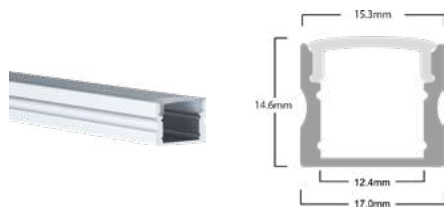

H: 14 mm L: 100 mm W: 17 mm

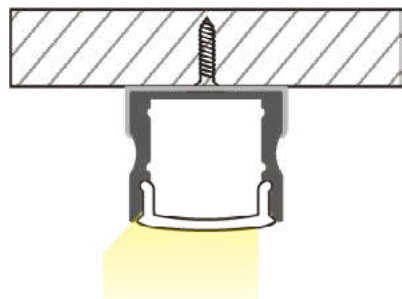

LEDAP1417200

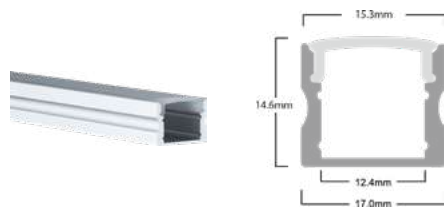

H: 14 mm L: 200 mm W: 17 mm

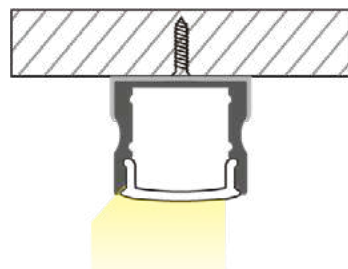

·Installation method

LEDAP0917200C



H: 9 mm L: 200 mm W: 17 mm

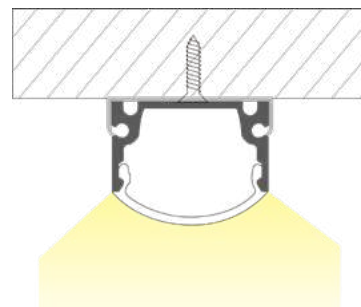

LEDAP1421200

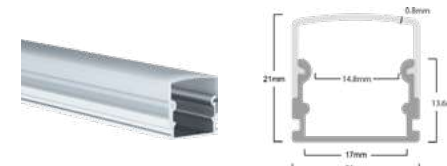

H: 14 mm L: 200 mm W: 21 mm

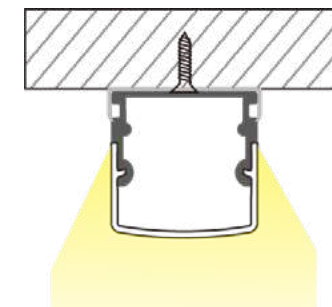

LEDAP0418200



H: 5 mm L: 200 mm W: 18 mm

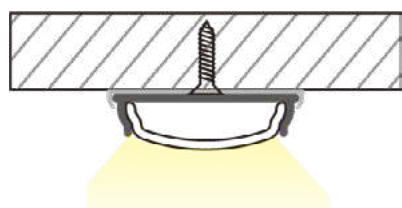

·Installation method

LEDAP0813200



H: 13 mm L: 200 mm W: 8 mm

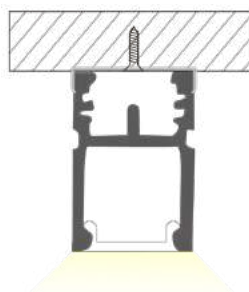

LEDAP0817200B



H: 17 mm L: 200 mm W: 8 mm

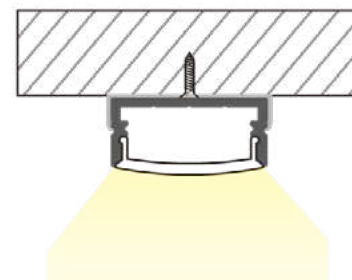

LEDAP0917200



H: 17 mm L: 200 mm W: 9 mm

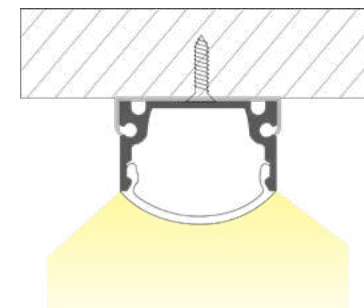

PERFIL SUPERFICIE | PERFIL DE SUPERFÍCIE | SURFACE PROFILE | PROFILO SUPERFICIALE

LEDAPS0115100A



H: 1,5 mm L: 100 mm W: 15 mm

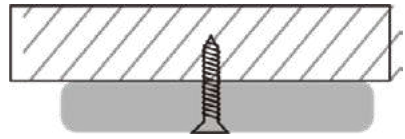

LEDAPS1024200A



H: 10 mm L: 200 mm W: 24 mm

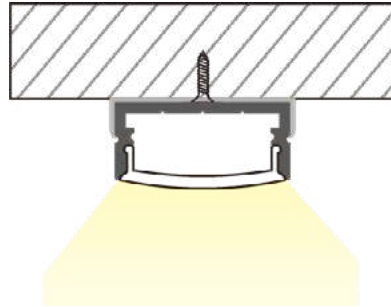

LEDAPS1849200A



H: 17,7 mm L: 200 mm W: 48,5 mm

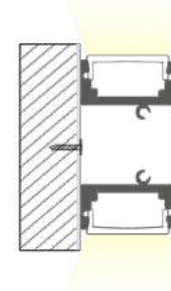

LEDAPS2525200A

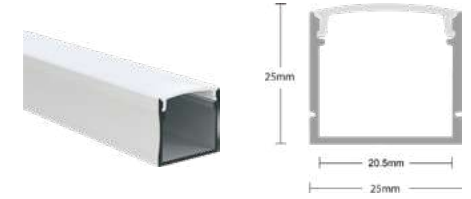

H: 20 mm L: 200 mm W: 25 mm

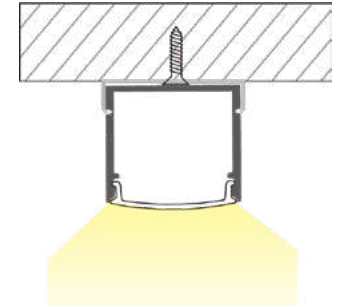

LEDAPS1116200



H: 14 mm L: 200 mm W: 17 mm

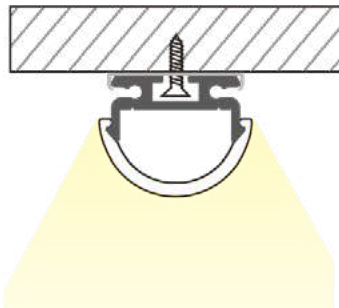

LEDAPS1417200A

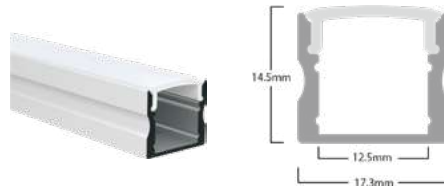

H: 14,5 mm L: 200 mm W: 17,3 mm

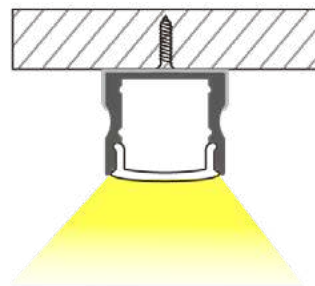

LEDAPS810200A

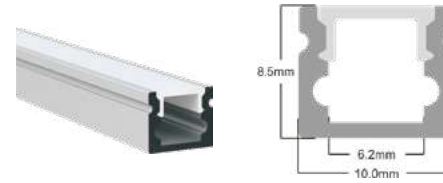

H: 8,4 mm L: 200 mm W: 10 mm

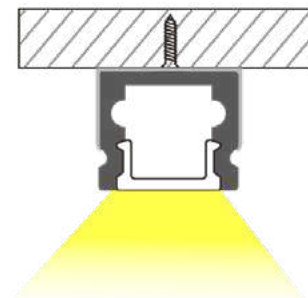

LEDAPS2525200N

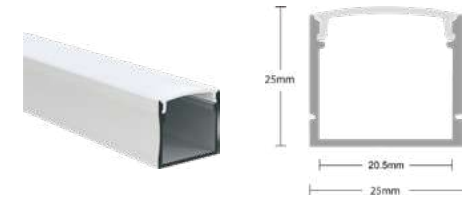

H: 20 mm L: 200 mm W: 25 mm

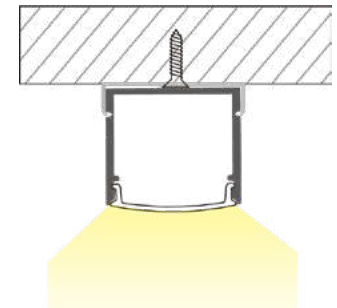

PERFIL SUPERFICIE ESQUINA | PERFIL DE SUPERFÍCIE DE CANTO | CORNER SURFACE PROFILE | PROFILO ANGOLARE SUPERFICIALE

LEDAP1919050



H: 19 mm L: 200 mm W: 19 mm

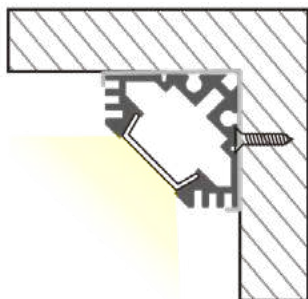

LEDAP1919100



H: 19 mm L: 100 mm W: 19 mm

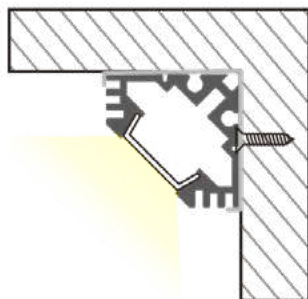

PERFIL SUPERFICIE ESQUINA | PERFIL DE SUPERFÍCIE DE CANTO | CORNER SURFACE PROFILE | PROFILO ANGOLARE SUPERFICIALE

LEDAPS2929200A

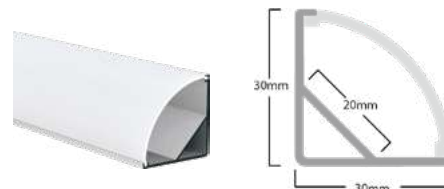

H: 29,7 mm L: 200 mm W: 29,7 mm

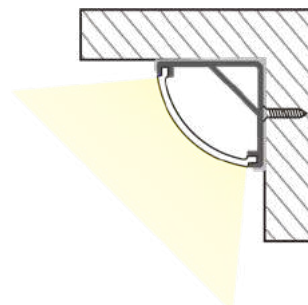

LEDAPS3030200A



H: 29,7 mm L: 200 mm W: 29,7 mm

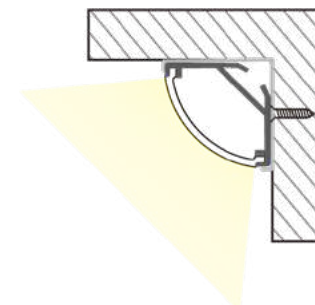

LEDAP1616200

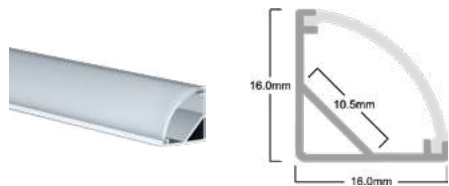

H: 16 mm L: 200 mm W: 16 mm

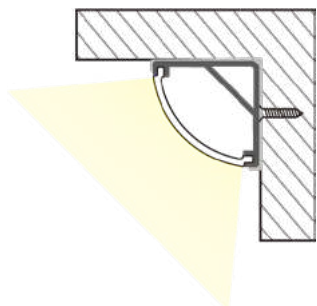

LEDAPS1818200A



H: 18 mm L: 200 mm W: 18 mm

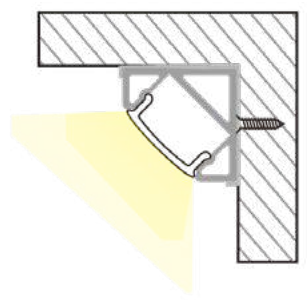

PERFIL SUSPENSIÓN | PERFIL DE SUSPENSÃO | SUSPENSION PROFILE | PROFILO A SOSPENSIONE

LEDAPP2027200SA

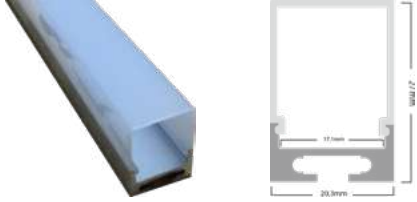

H: 20,3 mm L: 200 mm W: 77 mm

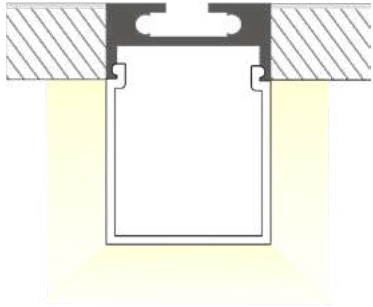

LEDAPP3030200A



H: 30 mm L: 200 mm W: 30 mm

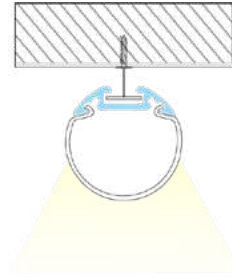

·Installation method

LEDAPP5070300A

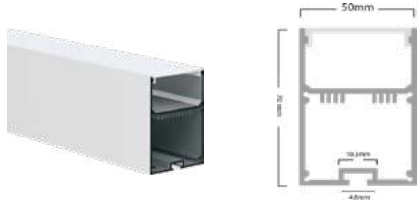

H: 50 mm L: 300 mm W: 70 mm

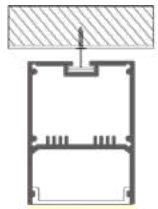

·Installation method

PERFIL EMPOTRABLE | PERFIL EMBUTIDO | RECESSED PROFILE | PROFILO INCASSATO

LEDAP0725200



H: 7 mm L: 200 mm W: 25 mm

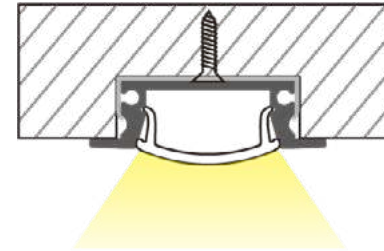

·Installation method

LEDAPR0725200A

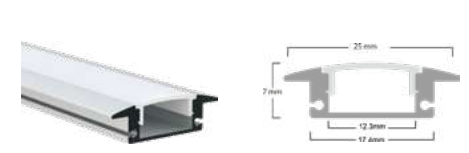

H: 7 mm L: 200 mm W: 255 mm

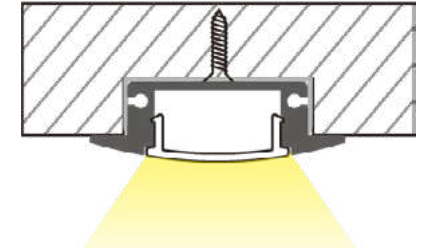

LEDAPR0823200A



H: 8 mm L: 200 mm W: 23 mm

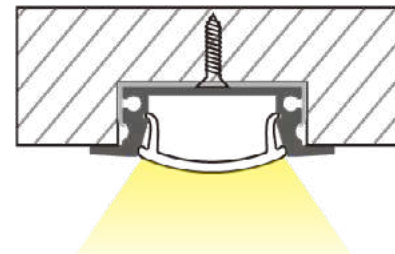

LEDAPR2836200A



H: 28 mm L: 200 mm W: 36 mm

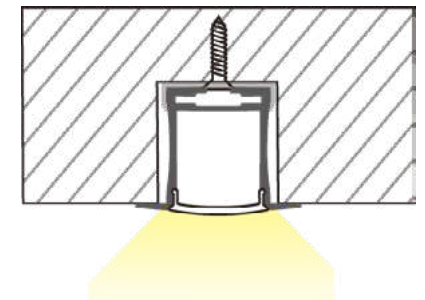

PERFIL EMPOTRABLE | PERFIL EMBUTIDO | RECESSED PROFILE | PROFILO INCASSATO

LEDAPR5535200A



H: 35 mm L: 200 mm W: 55 mm

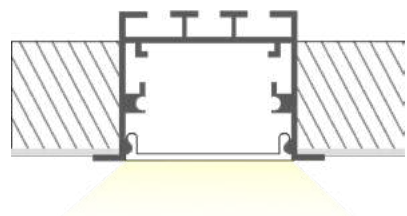

LEDAPR1425200A

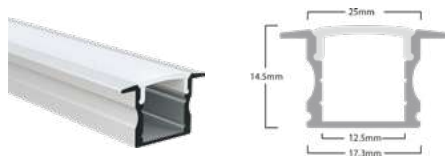

H: 14 mm L: 200 mm W: 25 mm

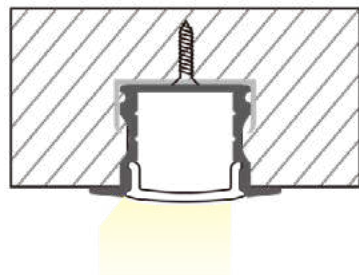

PERFIL EMPOTRABLE SUELO | PERFIL EMBUTIDO NO CHÃO | RECESSED FLOOR PROFILE | PROFILO INCASSATO A PAVIMENTO

LEDAPF1127200A



H: 11 mm L: 200 mm W: 16 mm

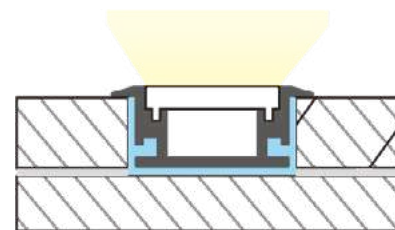

LEDAPF2126200A

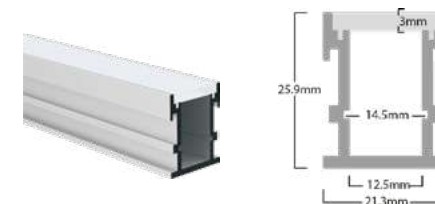

H: 26 mm L: 200 mm W: 21 mm

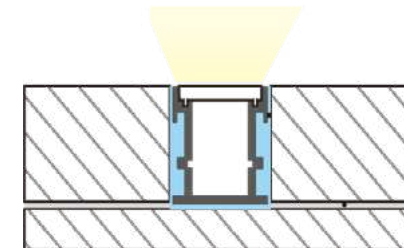

LEDAPS178200A

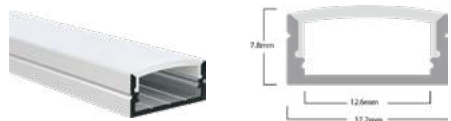

H: 8 mm L: 200 mm W: 17,3 mm

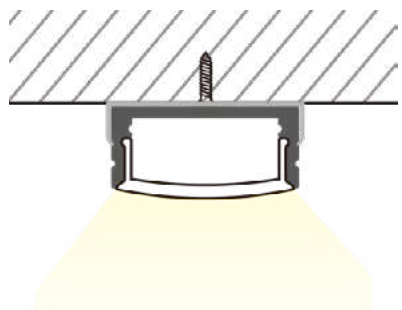



Driver IP20

ROB501200	ROB32800	DRIVER42105PIN
Driver 48W 1200mA/33-40V IP20 220-240V Driver 48W 1200mA/33-40V IP20 220-240V Driver 48W 1200mA/33-40V IP20 220-240V Alimentatore 48W 1200mA/33-40V IP20 220-240V	Driver32W 600-800mA IP20 28-40V 200-260V Driver32W 600-800mA IP20 28-40V 200-260V Driver32W 600-800mA IP20 28-40V 200-260V Alimentatore32W 600-800mA IP20 28-40V 200-260V	DRIVER 42W 28-42Vdc / 850-1050mA / 200-240V / IP20 / Classe II DRIVER 42W 28-42Vdc / 850-1050mA / 200-240V / IP20 / Classe II DRIVER 42W 28-42Vdc / 850-1050mA / 200-240V / IP20 / Classe II DRIVER 42W 28-42Vdc / 850-1050mA / 200-240V / IP20 / Classe II
DRIVER48120	GODRIVER160105	DRIVER3012VIP20
DRIVER 48W 1200mA 33-40V IP20 220-240v Classe II DRIVER 48W 1200mA 33-40V IP20 220-240v Classe II DRIVER 48W 1200mA 33-40V IP20 220-240v Classe II DRIVER 48W 1200mA 33-40V IP20 220-240v Classe II	DRIVER 60W 1050mA / 76-229VDC / IP20 200-240VAC CLASSE I + II DRIVER 60W 1050mA / 76-229VDC / IP20 200-240VAC CLASSE I + II DRIVER 60W 1050mA / 76-229VDC / IP20 200-240VAC CLASSE I + II DRIVER 60W 1050mA / 76-229VDC / IP20 200-240VAC CLASSE I + II	Driver 30W 12V IP20 Driver 30W 12V IP20 Driver 30W 12V IP20 Alimentatore 30W 12V IP20
DRIVER6024VIP20	DRIVER6012VIP20	DRIVER10012VIP20
Driver 60W 24V IP20 Driver 60W 24V IP20 Driver 60W 24V IP20 Alimentatore 60W 24V IP20	Driver 60W 12V IP20 Driver 60W 12V IP20 Driver 60W 12V IP20 Alimentatore 60W 12V IP20	Driver 100W 12V IP20 Driver 100W 12V IP20 Driver 100W 12V IP20 Alimentatore 100W 12V IP20
DRIVER10024VIP20	DRIVER15012VIP20	DRIVER15024VIP20
Driver 100W 24V IP20 Driver 100W 24V IP20 Driver 100W 24V IP20 Alimentatore 100W 24V IP20	Driver 150W 12V IP20 Driver 150W 12V IP20 Driver 150W 12V IP20 Alimentatore 150W 12V IP20	Driver 150W 24V IP20 Driver 150W 24V IP20 Driver 150W 24V IP20 Alimentatore 150W 24V IP20
DRIVER20012VIP20	DRIVER20024VIP20	DRIVER36024IP20
Driver 200W 12V IP20 Driver 200W 12V IP20 Driver 200W 12V IP20 Alimentatore 200W 12V IP20	Driver 200W 24V IP20 Driver 200W 24V IP20 Driver 200W 24V IP20 Alimentatore 200W 24V IP20	Driver 360W 24V IP20 Driver 360W 24V IP20 Driver 360W 24V IP20 Driver 360W 24V IP20
DRIVER1512VIP20	DRIVER3024VIP20	
Driver 15W 12V IP20 Driver 15W 12V IP20 Driver 15W 12V IP20 Alimentatore 15W 12V IP20	Driver 30W 24V IP20 Driver 30W 24V IP20 Driver 30W 24V IP20 Alimentatore 30W 24V IP20	



Driver IP67

GODRIVER60105	GODRIVER60120	GODRIVER60180
DRIVER 60W 34-57v/1050mA / IP67 / 120-240V DRIVER 60W 34-57v/1050mA / IP67 / 120-240V DRIVER 60W 34-57v/1050mA / IP67 / 120-240V DRIVER 60W 34-57v/1050mA / IP67 / 120-240V	Driver 60W 25-50 V / 1200mA 120-240V IP67 Driver 60W 25-50 V / 1200mA 120-240V IP67 Driver 60W 25-50 V / 1200mA 120-240V IP67 Alimentatore 60W 25-50 V / 1200mA 120-240V IP67	Driver 60W 25-54V 800 - 1800mA 100-240V IP67 (TITAN) Driver 60W 25-54V 800 - 1800mA 100-240V IP67 (TITAN) Driver 60W 25-54V 800 - 1800mA 100-240V IP67 (TITAN) Alimentatore 60W 25-54V 800 - 1800mA 100-240V IP67 (TITAN)
DRIVER10012V	DRIVER10024V	DRIVER3024V
Driver 100W 12V IP67 Driver 100W 12V IP67 Driver 100W 12V IP67 Alimentatore 100W 12V IP67	Driver 100W 24V IP67 Driver 100W 24V IP67 Driver 100W 24V IP67 Alimentatore 100W 24V IP67	Driver 30W 24V IP67 Driver 30W 24V IP67 Driver 30W 24V IP67 Alimentatore 30W 24V IP67
DRIVER3012V	DRIVER1512V	DRIVER6024V
Driver 30W 12V IP67 Driver 30W 12V IP67 Driver 30W 12V IP67 Alimentatore 30W 12V IP67	Driver 15W 12V IP67 Driver 15W 12V IP67 Driver 15W 12V IP67 Alimentatore 15W 12V IP67	Driver 60W 24V IP67 Driver 60W 24V IP67 Driver 60W 24V IP67 Alimentatore 60W 24V IP67
DRIVER6012V	DRIVER30024IP67	DRIVER15024IP67
Driver 60W 12V IP67 Driver 60W 12V IP67 Driver 60W 12V IP67 Alimentatore 60W 12V IP67	Driver 300W 24V IP67 SLIM Driver 300W 24V IP67 SLIM Driver 300W 24V IP67 SLIM Driver 300W 24V IP67 SLIM	Driver 150W 24V IP67 SLIM Driver 150W 24V IP67 SLIM Driver 150W 24V IP67 SLIM Driver 150W 24V IP67 SLIM
DRIVER20024IP67	DRIVER35012IP67	
Driver 200W 24V IP67 SLIM Driver 200W 24V IP67 SLIM Driver 200W 24V IP67 SLIM Driver 200W 24V IP67 SLIM	Driver 350W 12V IP67 SLIM Driver 350W 12V IP67 SLIM Driver 350W 12V IP67 SLIM Driver 350W 12V IP67 SLIM	



ZONAS ATEX
ZONAS ATEX
ATEX ZONES
ZONE ATEX



DEPORTIVO
ESPORTIVO
SPORTS
SPORTIVO



DOMÉSTICO
DOMESTICO
DOMESTIC
DOMESTICO



VIAL Y URBANO
VIALE URBANO
ROAD AND URBAN
VIALE URBANO



CONSTRUCCIÓN
CONSTRUCÃO
CONSTRUCTION
COSTRUZIONE



HOSPITALES
HOSPITAIS
HOSPITALS
OSPEDALI



APARCAMIENTOS
ESTACIONAMENTOS
PARKING LOTS
PARCHEGGI



EDUCACIÓN Y OFICINAS
EDUCAÇÃO E ESCRITÓRIOS
EDUCATION AND OFFICES
EDUCAZIONE E UFFICI



EDIFICIOS PÚBLICOS
EDIFICIIS PUBLICIS
PUBLIC BUILDINGS
EDIFICI PUBBLICI



HOTELES Y RESTAURACIÓN
HOTELS E RESTAURAÇÃO
HOTELS AND RESTAURANTS
HOTEL E RISTORAZIONE



INDUSTRIAL
INDUSTRIAL
INDUSTRIAL
INDUSTRIALE



COMERCIAL
COMMERCIAL
COMMERCIAL
COMMERCIALE

INDUSTRIAS ROBLAN

INDÚSTRIAS ROBLAN
ROBLAN INDUSTRIES
INDUSTRIE ROBLAN

